

SYNTHESIS OF CHIRAL CAGE ANNULATED MACROCYCLES

GRANT ALEXANDER BOYLE

2006

**A dissertation submitted to the School of Chemistry, Faculty of Science and Agriculture,
University of KwaZulu-Natal, Durban, for the degree of Master of Science**

As the candidate's supervisor, I have/ have not approved this dissertation for submission.

Supervisor:

Signed: ----- Name:----- Date:-----

Co-supervisor:

Signed: ----- Name:----- Date:-----

DECLARATION

I HEREBY DECLARE THAT THE WORK PRESENTED IN THIS DISSERTATION IS MY OWN, UNAIDED WORK AND HAS NEVER BEFORE BEEN SUBMITTED FOR ANY DEGREE AT THIS OR ANY OTHER UNIVERSITY.

G.A. BOYLE.

----- day of ----- 2006

ACKNOWLEDGMENTS

I thank God for watching over me and giving me strength during the many difficult times.

I thank all my mentors for contributing to my birth as a chemist:

Dr H.G. Kruger	Supervisor
Dr G.E.M. Maguire	Co-supervisor
Dr T. Govender	Colleague

I thank the technical staff at the university of KwaZulu-Natal for all their assistance.

I thank my family and friends for their continuous support throughout the course of this degree. I dedicate this work to them.

CONTENTS

	Page No.
Title page	i
Declaration	ii
Abstract	iii
Acknowledgements	iv
Contents	v
List of Tables	viii
List of Schemes	ix
List of Figures	xi
CHAPTER 1	
Introduction	
Cage Compounds	1
Crown Ethers	2
Synthesis of Crown Ethers	3
Types of Crown Ethers	4
Applications of Crown Compounds	8
Chirality	10
Chiral Crown Compounds	12
Applications in Asymmetric Synthesis	13
References	16
CHAPTER 2	
Attempted Synthesis of Sugar Based Macrocycles	
Introduction	19
Asymmetric Catalysis	21

Previous Asymmetric Michael Additions using Cage Annulated Macrocycles	23
Synthesis of Macrocycles	25
Attempted Synthesis of Macrocycles	26
Conclusion	38
References	40
CHAPTER 3	
Synthesis of Chiral Cage Annulated Macrocycles	
Introduction	42
Synthesis of Macrocycles	42
Results and Discussion	45
Conclusion	47
References	48
CHAPTER 4	
Attempted Synthesis of a Chiral Luminescent Sensor	
Introduction	49
Results and Discussion	54
Conclusion	59
References	60
CHAPTER 5	
Conclusion	61
CHAPTER 6	
Experimental	
Experimental for Chapter 2	63
Experimental for Chapter 3	70
Experimental for Chapter 4	73
References	75

APPENDIX 1 : Spectra

76

SUPPLEMENTARY MATERIAL:

A CD accompanying this dissertation contains the following:

Text of Chapters 1-6

Appendix 1

LIST OF TABLES

	Page No.
Table 1: Michael addition reaction of 2-nitropropane 61 and chalcone 60 catalysed by potassium <i>t</i> -butoxide and macrocycles 96-97 at 25°C	46
Table 2: Comparison of results obtained with different bases in the Michael addition reaction of 2-nitropropane 61 and chalcone 60 .	47

LIST OF SCHEMES

	Page No.
Scheme 1: Accidental synthesis of the first crown ether	2
Scheme 2: An example of the template effect technique	3
Scheme 3: Example of a two-step condensation reaction	4
Scheme 4: Alkylation of benzyl methyl ketone using crown ethers as phase transfer catalysts	8
Scheme 5: Michael addition of phenylacetate to acrylate using a crown ether catalyst	9
Scheme 6: Oxidation using KMnO_4 in the presence of crown ether	9
Scheme 7: Reduction of cyclohexanone with NaBH_4 in the presence of crown ether	9
Scheme 8: Nucleophilic substitution using 18-crown-6	10
Scheme 9: Darzens reaction catalysed by a chiral crown ether	14
Scheme 10: Oxidation reaction catalysed by a chiral crown ether	14
Scheme 11: Epoxidation using a chiral crown ether	14
Scheme 12: Michael addition reaction catalysed by a chiral crown ether	15
Scheme 13: Synthesis of pentacyclo[5.4.0.0 ^{2,6} .0 ^{3,10} .0 ^{5,9}] undecane-8,11-dione	19
Scheme 14: Improved PCU crown ether synthesis	20
Scheme 15: Illustration of Michael Addition of methyl phenylacetate to methyl acrylate	22
Scheme 16: Michael addition of methyl phenylacetate to methyl acrylate	23
Scheme 17: Michael addition of 2-nitropropane to chalcone	24
Scheme 18: Synthesis of PCU ditosylate 87	27

Scheme 19:	Synthesis of methyl ester acetonide 93	28
Scheme 20:	Reduction of ester	29
Scheme 21:	Grignard reaction to form diols 95 and 96	29
Scheme 22:	Marchand's cyclization procedure	30
Scheme 23:	Retrosynthetic pathway to Macrocycles	31
Scheme 24:	Synthesis of novel cage amino diol 103	32
Scheme 25:	Attempted synthesis of PCU-amino-ditosylate 105	32
Scheme 26:	Reaction of diol 103 with thionyl chloride	33
Scheme 27:	Attempted bromination of the diol 103	34
Scheme 28:	Synthesis of Hydrobromide salt 108	34
Scheme 29:	Attempted coupling of hydrobromide salt 108 to chiral diol 94	35
Scheme 30:	Envisaged synthetic route to chiral diamine compounds 113-115	36
Scheme 31:	Tosylation of 2-chloroethanol 116	36
Scheme 32:	Attempted coupling to the diol 96	37
Scheme 33:	Attempted coupling using 1-bromo-2-chloroethane 119	38
Scheme 34:	Synthesis of <i>N</i> -methyl amino alcohols 125-126	43
Scheme 35:	Synthesis of PCU-amino-diol ligands 127-128	44
Scheme 36:	Synthesis of novel PCU annulated macrocycles 130-131	45
Scheme 37:	Retrosynthetic approach to chiral PET sensor 134	55
Scheme 38:	Synthesis of 9-(bromomethyl)anthracene 141	56
Scheme 39:	Synthesis of anthracene diol 137	56
Scheme 40:	Attempted synthesis of anthracene ditosylate 142	57
Scheme 41:	Synthesis of anthracene dichloro compound 136	58
Scheme 42:	Cyclization reaction to form PET sensor 134	58

LIST OF FIGURES

		Page No.
Figure 1	Diagram depicting the process of fluorescence	49
Figure 2:	Schematic showing Receptor-Fluorophore system in the “off” state	50
Figure 3:	Orbital energy diagram depicting PET	51
Figure 4:	Receptor-Fluorophore system in the “on” state	51
Figure 5:	Orbital energy diagram depicting the “on” state	52

CHAPTER 1

INTRODUCTION

CAGE COMPOUNDS

Over the years, saturated polycyclic “cage” compounds have been of special interest to organic chemists.^{1,2,3} Cage compounds contain unusual C-C-C bond angles that deviate significantly from 109.5°. Intensive study of these compounds has given insight into how the unusual geometry of these cage molecules affects their chemical reactivity and behavior.^{1,4} A number of unique cage compounds are known. Below are a few examples of some of the better known cages.

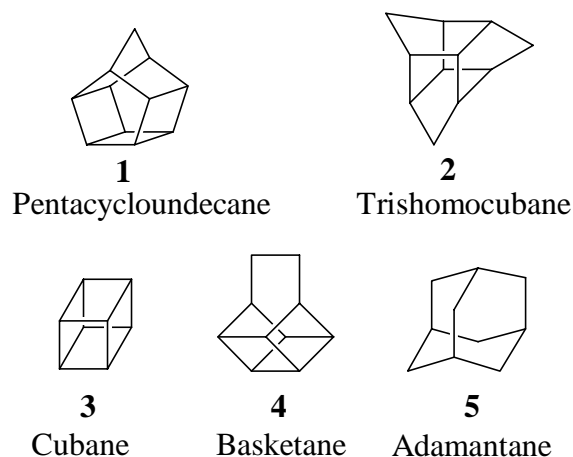

Incorporation of cage compounds into pharmaceutical drugs is an interesting and exciting application. It has been shown^{5,6,7} that incorporation of these compounds into pharmaceuticals induces a range of positive effects:

- Reduced metabolic degradation due to the bulkiness of the hydrocarbon cage structure increases the drug's affinity for lipophilic regions in receptor molecules.
- Lipophilicity of the cage molecule promotes transport across cell membranes, including the blood-brain barrier (BBB) and the central nervous system (CNS).

Adamantane (**5**) has been widely used in various pharmaceutical compounds. The most well known example of this being the anti-Parkinson's drug Amantadine (**6**).⁸

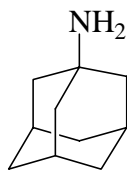

6

Since the introduction of this drug, considerable synthetic effort has taken place in the field of polycyclic chemistry^{1,2,3} with the intention of incorporating cage compounds of various types into drugs. Recently, an important review by Geldenhuys *et al.* focusing on the pharmaceutical activity of pentacycloundecane (PCU) derivatives was published.

The rest of this dissertation will focus exclusively on the PCU cage (1) and particularly on its incorporation into crown ethers.

CROWN ETHERS

Crown compounds were accidentally discovered by Pedersen in 1967.⁹ He found the macrocyclic polyether (7) as a by-product while synthesising bis[2-(2-hydroxyphenoxy)-ethyl]-ether (8).

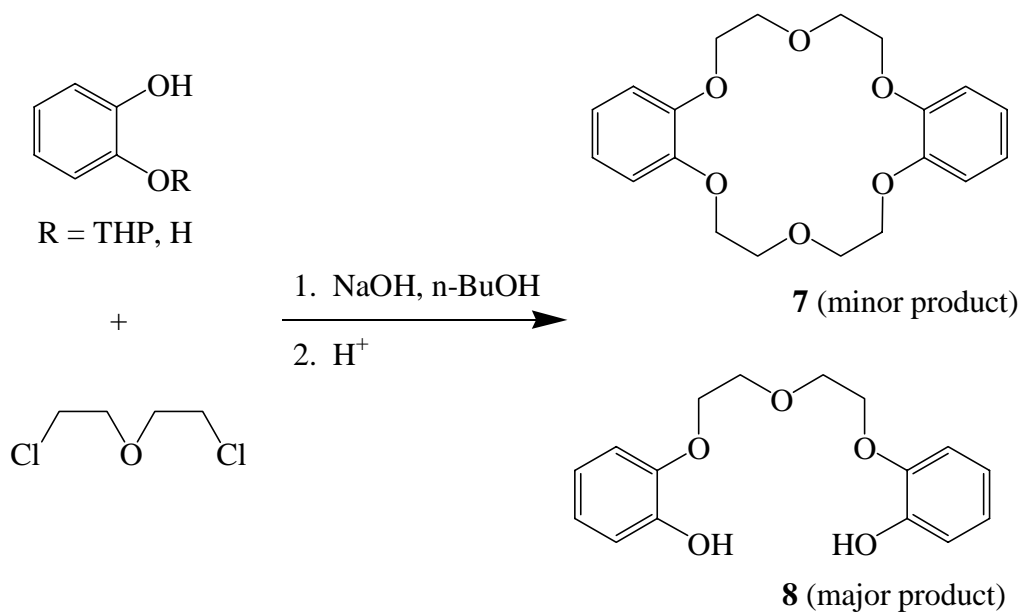

Scheme 1: Accidental synthesis of the first crown ether

Pedersen observed that these cyclic compounds form stable complexes with salts of alkali metals. He also noted that these complexes are soluble in organic solvents including non-polar solvents such as benzene and carbon tetrachloride. The stability of these complexes depends on the relative

size of the ionic radius of the alkali metal cation with respect to the cavity of the macrocyclic polyether.¹⁰ This groundbreaking research stimulated interest to such an extent that Christensen *et al.* published a review¹¹ listing 221 kinds of crown compounds, a mere seven years after Pederson's initial report.

SYNTHESIS OF CROWN ETHERS^{12,13,14,15}

Standard synthetic techniques employed for the formation of ethers, secondary amines and thioethers are generally used to synthesise crown compounds. Linear polymeric by-products are commonly formed in these reactions. Various methods are therefore employed to depress the formation of these by-products. These include the use of high dilution, the template effect and two-step condensation reactions. High dilution techniques favour the intramolecular (S_N2) reaction over the intermolecular (S_N2) reaction after the condensation of one of the terminal groups on both bifunctional compounds. The intramolecular reaction generally leads to ring closure while the intermolecular reaction generally leads to chain extension. The template effect (Scheme 2) involves the use of a metal ion chosen on the basis of its ionic diameter. Alkali metal ions are most commonly utilized for this, however, transition metals have also been employed. The template effect uses the ionic dipole interaction between the metal ion and the intermediates to promote ring closure.

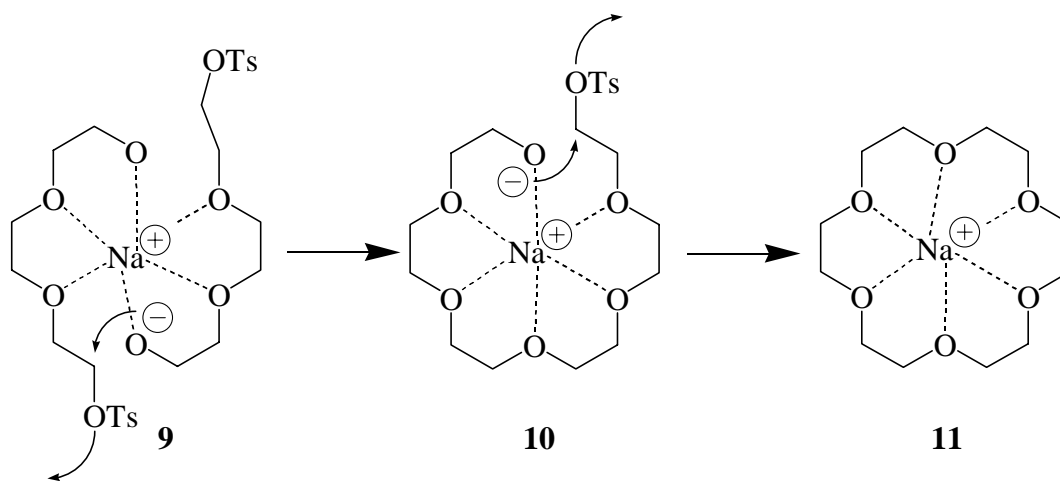

Scheme 2: An example of the template effect technique¹²

In the two-step condensation technique (Scheme 3), one of the terminal groups on both bifunctional compounds is protected (p), while the other is condensed. The protecting group is removed and the intermediate purified. The remaining functional groups are then condensed to form the cyclic product.

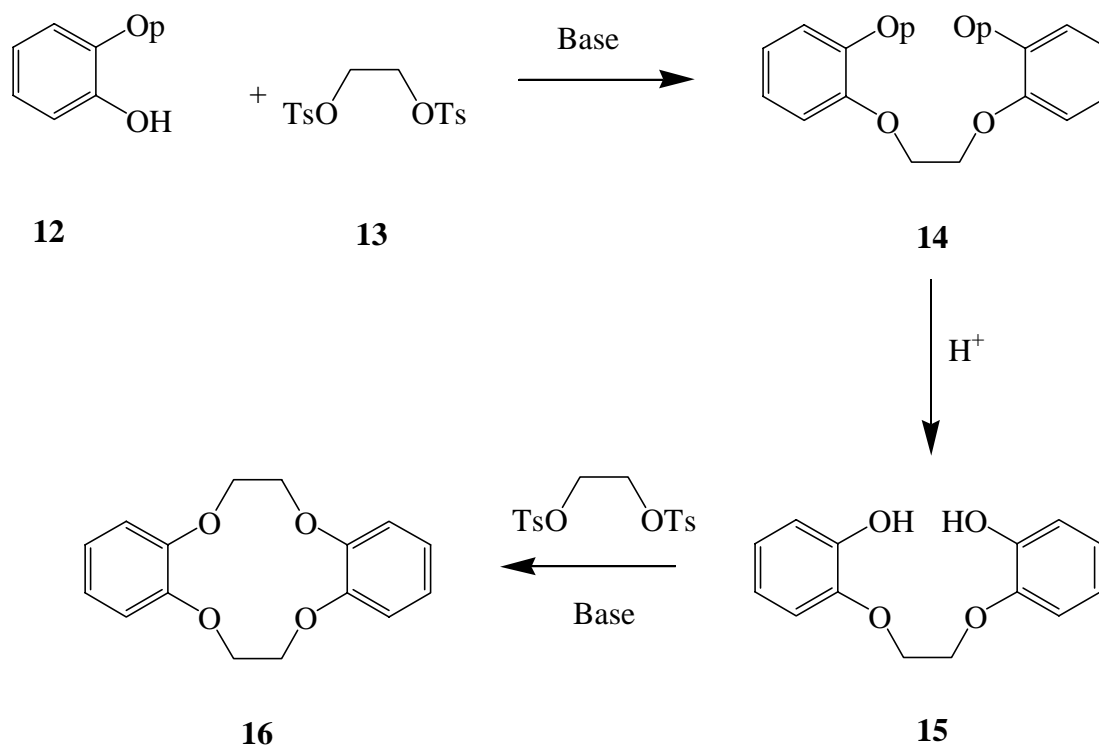

Scheme 3: Example of a two-step condensation reaction

TYPES OF CROWN ETHERS

Crown compounds are described¹⁵ as macrocyclic compounds having heteroatoms such as O, N, or S as the electron donor atoms in their structures. They are able to form complexes with cations that fit into their cavities. Nomenclature of these types of compounds is described in early reviews.^{14,15}

Crown ethers are macrocyclic polyethers containing only O donor atoms, azacrown ethers have at least one N donor atom and thiacrown ethers have at least one S donor atom. Cryptands are multicyclic crown compounds and bind metal ions more selectively¹⁶ and with a larger binding constant than normal crown ethers. Below are examples of the different types of crown ethers.

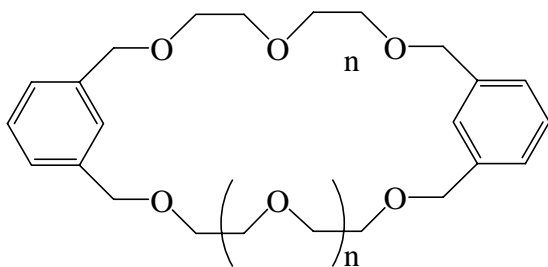

17

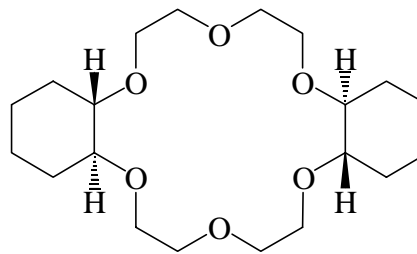
aromatic¹⁷

18

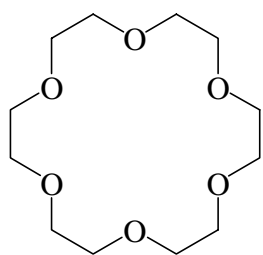
alicyclic¹⁸

19

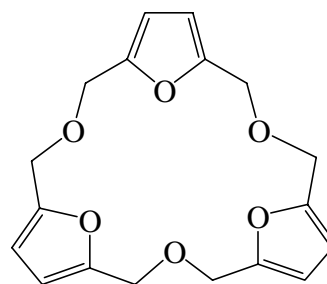
alkylene oxides¹⁹

20

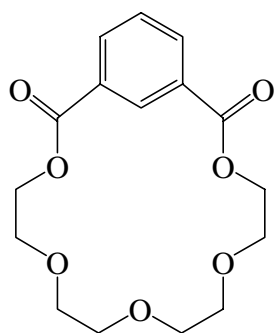
heterocyclic²⁰

21

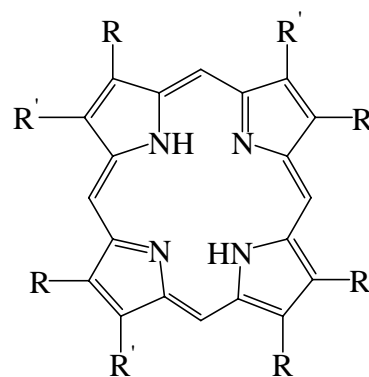
cyclic polyether esters²¹

22

cyclic polyamines²²

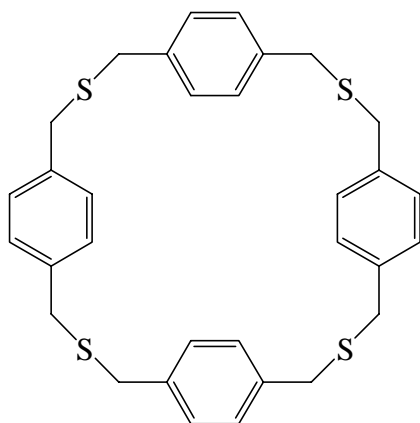

23

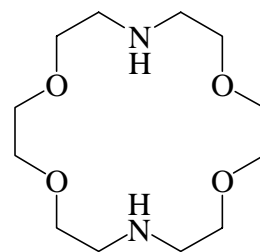
cyclic polythiaethers²³

24

azacrown ethers

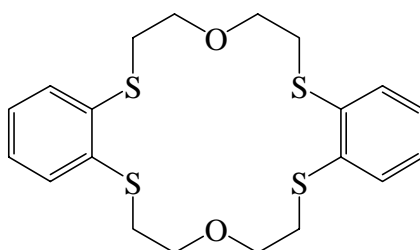

25

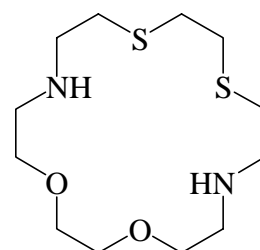
thiacrown ethers²⁴

26

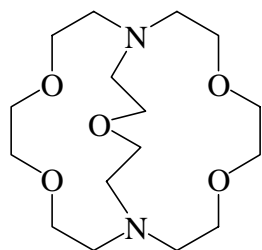
azathiacrown ethers²⁵

27

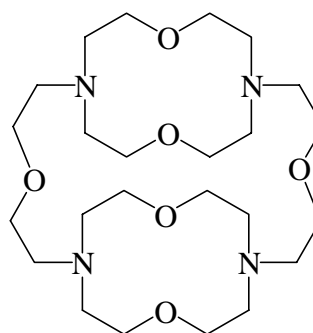
cryptand²⁶

28

bicyclic cryptand²⁷

Lariat crown ethers (eg. 29)²⁸ usually form more stable complexes than simple crowns, especially if the flexible chains have additional binding sites. In some cases the side chain is utilised to supply the counter ion, improving the solubility of metal ion complexes in apolar solvents.

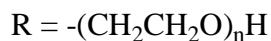
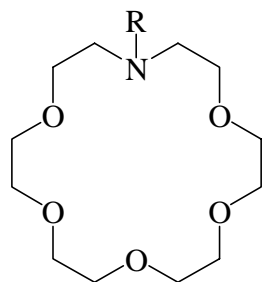

29

Functional groups on crown ethers are important. They affect complexation and can be used to prepare “immobilised” crown compounds. Immobilised crown ethers are synthesised either by copolymerisation of suitably functionalised macrocycles (*eg.* **30**) or by appending functional macrocycles to existing polymeric substrates (*eg.* **31**). These systems can be used for ion selective membranes, chromatographic stationary phase and even trace element enrichment of radionuclides.²⁹

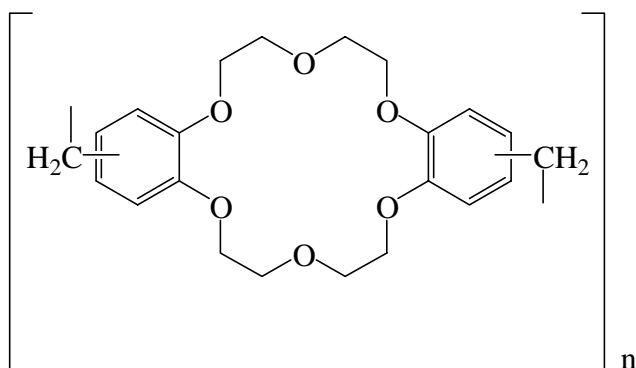

30

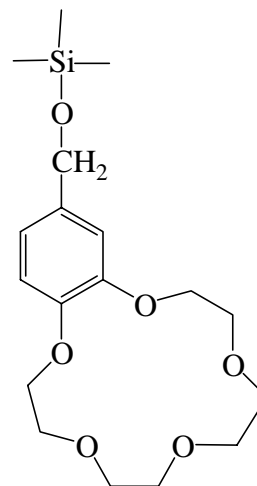

31

On their own, crown ethers are soluble in organic solvents. This means that they are difficult to recover when they are used in applications such as homogeneous catalysis. By incorporating the macrocycle into polymers they become insoluble and can be easily recovered.^{30,31} This property is particularly useful in large scale or continuous processes where recovery of the catalyst is a necessity. Generally, polymer supported crown ethers have been found to be less efficient than free crown ethers when used as catalysts in multiphase reaction systems.³² However, some

polymers incorporating functionalised crown ethers have shown greater efficiency by factors of up to 29.

APPLICATIONS OF CROWN COMPOUNDS

Crown compounds have been found to be useful in the separation of metal ions. They are able to form selective complexes with cations of specific ionic diameter. They can in fact be designed to fit a specific metal ion of certain ionic diameter. This can be considered to be a host-guest relationship. The crown ether is considered the “host” while the metal ion is complexed and can be considered to be the “guest”. This gave rise to the field of host-guest chemistry. Crown ethers in organic solvents are used to selectively extract inorganic salts from aqueous solutions. Crown compounds are applied in many fields, such as extraction, but exciting progress has been made in applications to organic synthesis. Crown ethers are useful in synthesis due to the fact they are able to make inorganic salts or alkali metals soluble even in non-polar solvents and are also useful because the counter ion is present in solution as a naked, highly active, non-solvated anion. The following are some examples of applications using crown ethers.

Condensation:³³ In condensation reactions where carbanions were generated it was observed that the reaction rates were increased significantly (10^2 ~ 10^5 times) when using crown ethers as phase transfer catalysts.

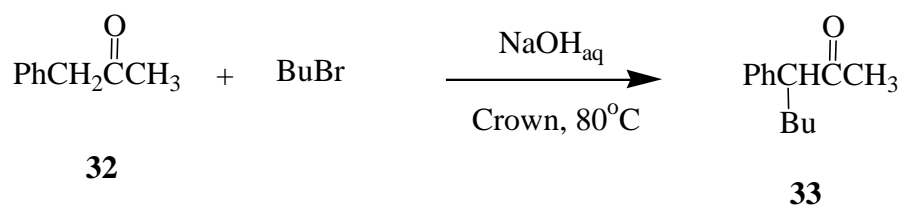

Scheme 4: Alkylation of benzyl methyl ketone using crown ethers as phase transfer catalysts

Addition:³⁴ The use of crown ethers as phase transfer catalysts in addition reactions such as the Michael addition is well documented in the literature. The chemical yields in these reactions are commonly as high as 96%. However, the advantage of using crown ethers as catalysts can be seen in the stereoselectivity that can be obtained.

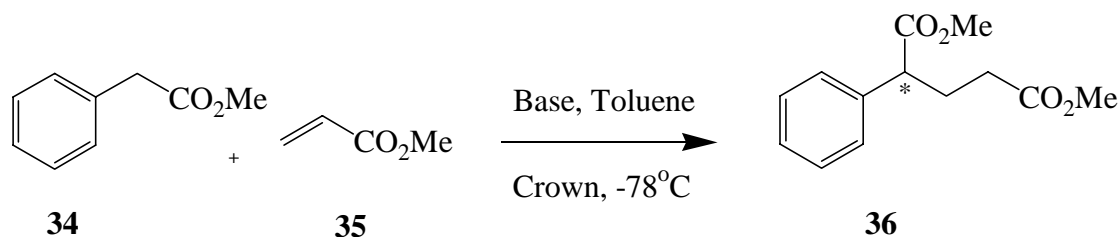

Scheme 5. Michael addition of phenylacetate to acrylate using a crown ether catalyst

Oxidation:³⁵ Potassium permanganate (KMnO_4) is a strong oxidising agent. It is insoluble in organic solvents due to its ionic character. Therefore the reaction below cannot be performed in organic solvents without the aid of a solubilising agent. However, in the presence of crown ethers, this reaction can be carried out in non-polar organic solvents, such as benzene, with great success.

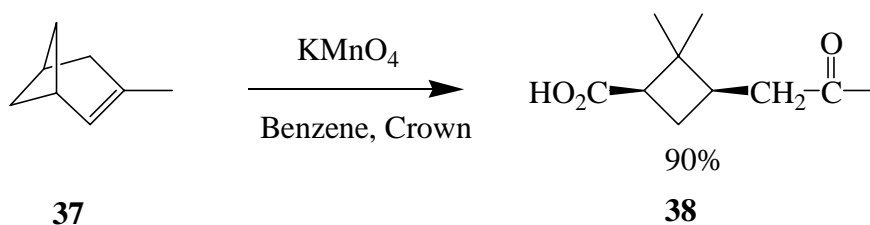

Scheme 6: Oxidation using KMnO_4 in the presence of crown ether

Reduction:³⁶ Reduction of 4-methyl-cyclohexanone (**39**) can result in a *cis* or *trans* alcohol product. The use of crown ethers in this reduction showed an increase in yield and selectivity towards the *trans* isomer.

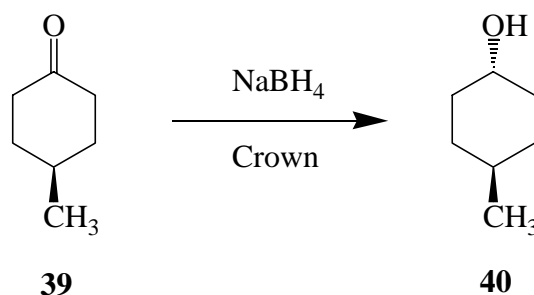

Scheme 7: Reduction of cyclohexanone with NaBH_4 in the presence of crown ether

Nucleophilic Substitution: Under conventional conditions, the reaction below cannot be carried out in aprotic solvents. However, with the use of catalytic amounts of 18-crown-6, it is possible to complex salts such as KF , thereby transferring them into the organic phase allowing the relatively unsolvated anions of these salts to carry out the nucleophilic substitution reaction.

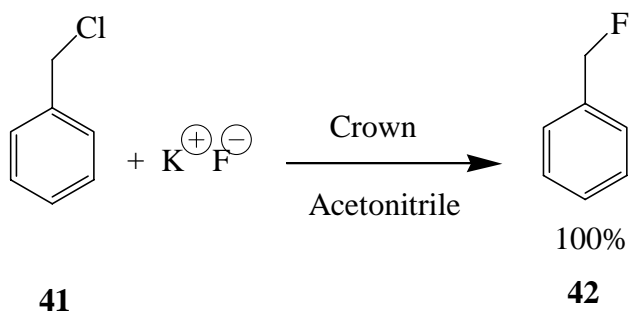

Scheme 8: Nucleophilic substitution using 18-crown-6

By making crown compounds chiral it becomes possible to achieve stereoselectivity in reactions involving crown ether catalysts.

CHIRALITY

All three-dimensional objects can potentially be chiral. By definition a chiral object cannot be superimposed upon its mirror image. Some categories of optically active compounds are illustrated below.³⁷

A carbon atom attached to four different groups is chiral e.g. the amino acid alanine.

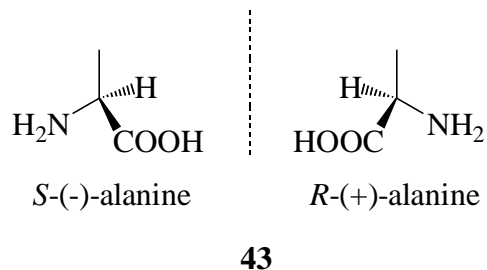

- Compounds that have restricted rotation do not need asymmetric atoms to be chiral *eg.* binaphthol (**44**)

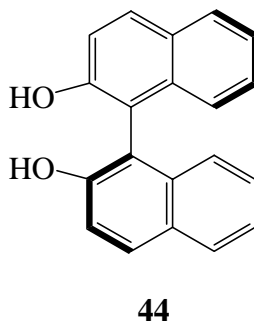

- A molecule containing an atom that has four bonds in tetrahedral symmetry will be optically active if the four groups are different.

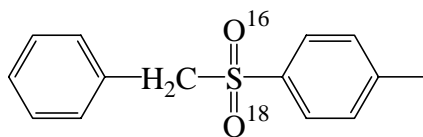

45

- Axially chiral compounds such as the allenes are optically active.³⁸

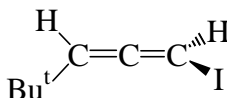

46

- A nitrogen atom that is part of a small ring containing electron withdrawing groups give rise to optical activity since the lone pair of electrons is analogous to a fourth group. The ring prevents inversion at the nitrogen centre at room temperature. The following is an example of such a chiral amine.^{38,39,40}

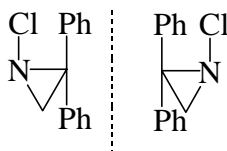

47

- Spiro compounds can also be chiral. The stereogenic centre is at the fusion of the rings. An example is the olive-fly pheromone (48).

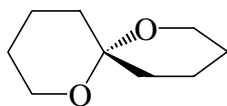

48

In the absence of an external chiral influence, enantiomers have identical chemical and physical properties except that they rotate plane-polarised light in opposite directions.

Molecular symmetry plays a crucial role in science and technology and this is mainly due to chirality being a major phenomenon in nature. Strict matching of chirality is essential since a variety of significant biological functions emerge through molecular recognition. Most of the important building blocks which make up the biological macromolecules of living systems do so

largely in one enantiomeric form. In eukaryotic cells this is the L-form.^{41,42} Different biochemical effects should be expected when the two enantiomers of a biologically active chiral compound, such as a drug, interact with a biochemical receptor site which is chiral.

This was brought to light tragically in the 1960's when the drug Thalidomide (**49**) resulted in a number of foetal deaths and deformities when used by pregnant women.³⁸ Both enantiomers of thalidomide have the same sedative effect (calming or tranquilising) but only the (-)-enantiomer causes foetal deformities.

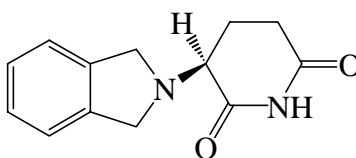

(-)-**49**

This discovery sparked an enormous scientific drive to synthesise chiral molecules and drugs in optically pure form.^{37,38,41,42,43} However, a large number of biologically active compounds and pharmaceutical drugs are still synthesised as racemates.^{38,42,44,45} This is often due to the lack of chiral synthetic routes for these compounds or the high cost of asymmetric synthesis. These mixtures therefore need to be resolved into their pure enantiomers. This resolution involves the use of enzymatic methods,^{46,47} chiral chromatography and in some cases fractional crystallisation with a co-chiral molecule. It was predicted that chiral crown ethers will play a major role in future enantiomeric separations.⁴⁸

CHIRAL CROWN COMPOUNDS

Pedersen, Lehn and Cram won the 1987 Nobel Prize in Chemistry for their contribution to the field of host-guest chemistry. Pedersen was mainly responsible for the initial synthesis of crown ethers, Lehn's contribution was the bicyclic and tricyclic compounds called cryptands and Cram's main contribution was his pioneering work on chiral crown ethers. The first chiral crown ether (**50**) was synthesised by Cram in 1972.

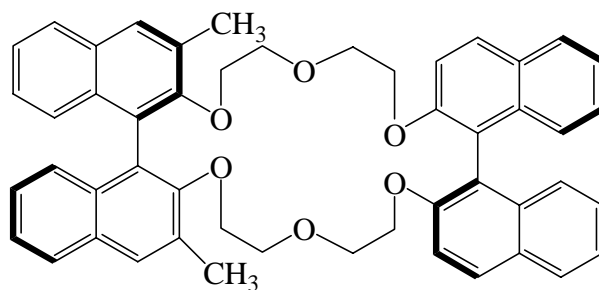
**(R,R)-50**

Since then many chiral crown ethers have been synthesised. The first chiral crown ether to incorporate a pentacyclo-undecane (PCU) derivative into a crown ether (**51**) was reported by Marchand *et al*⁴⁹ in 1999. It was used to determine enantioselectivity towards chiral ammonium salts using Cram's U-tube method.

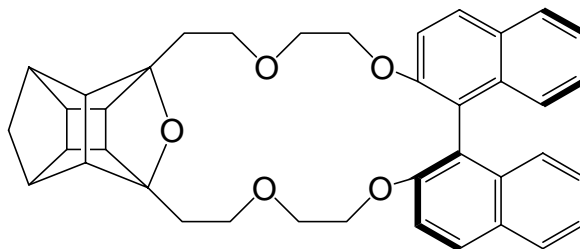
**(R)-51**

It was predicted that incorporation of the PCU cage into chiral crown ethers will enhance their enantioselectivity by providing:

- a high degree of rigidity
- ten extra chiral centres
- increased solubility in non-polar solvents.
- clear differentiation between the two faces of the ligand.

APPLICATIONS IN ASYMMETRIC SYNTHESIS

The field of chiral phase transfer catalysis is becoming an important area of research. Crown ethers are used as phase transfer catalysts (PTC) in a large number of reactions. The most commonly used PTC's are chiral quaternary ammonium salts such as the cinchona ligand (*eg.* **51**).⁵⁰ PTC can work in a liquid-liquid system or in a solid-liquid system by transporting reactants from one phase to another.

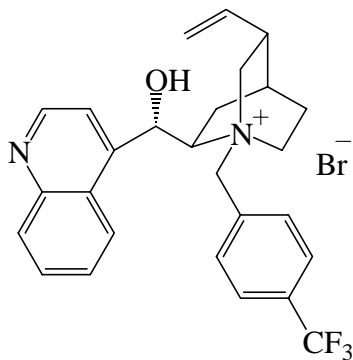

52

Chiral macrocycles have limited use due to the high cost of synthesising these compounds. However, unlike quaternary ammonium salts, they are less prone to degradation and therefore have higher catalytic turnover numbers. Some examples of reactions catalysed by chiral crown ethers are described below.

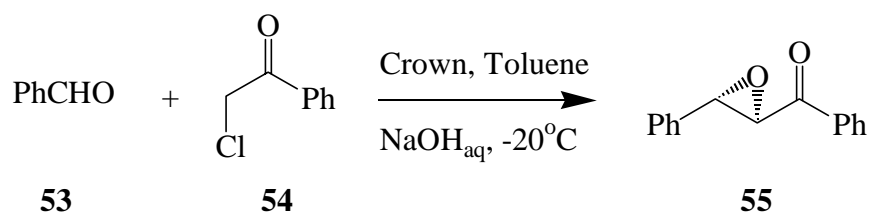

Scheme 9: Darzens reaction catalysed by a chiral crown ether⁵¹

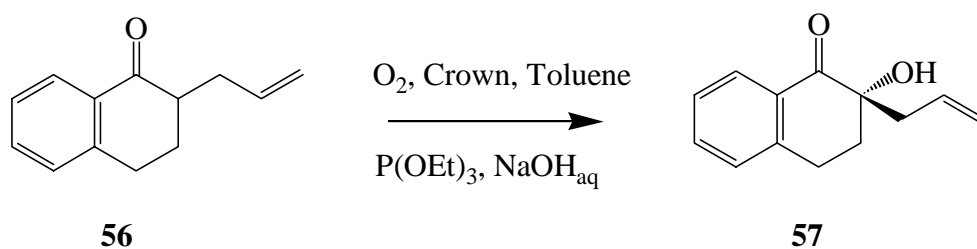

Scheme 10: Oxidation reaction catalysed by a chiral crown ether⁵²

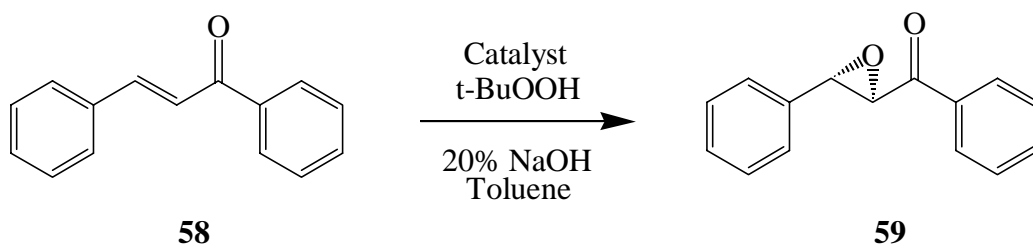

Scheme 11: Epoxidation using a chiral crown ether⁵³

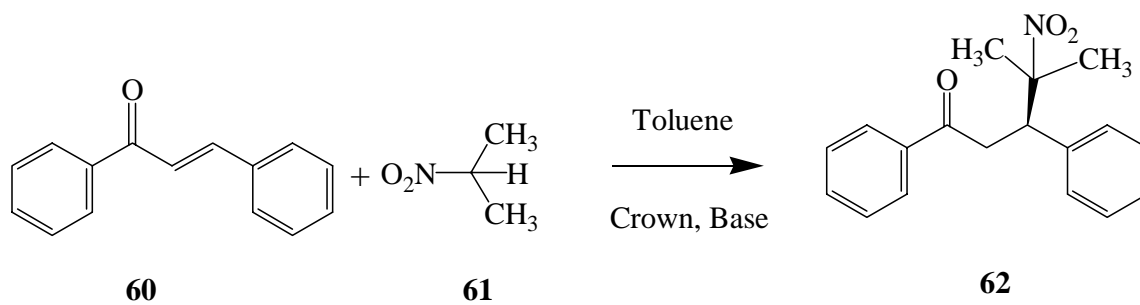

Scheme 12: Michael addition reaction catalysed by a chiral crown ether⁵⁴

This dissertation will describe the synthesis and attempted synthesis of chiral PCU annulated macrocycles, and their ability to catalyse Michael addition reactions.

REFERENCES

- 1 Marchand, A.P. *Chem. Rev.* **1989**, 89, 1011-1033
- 2 Griffin, G.W.; Marchand, A.P. *Chem. Rev.* **1989**, 89, 997.
- 3 Marchand, A.P. in *Advances in Theoretically Interesting Molecules*, R.P. Thummel, ed, JAI Press, Greenwich CT, **1989**, vol 1, 357.
- 4 Hart, H; Craine, D.J.; Hart , L.E. in *Organic Chemistry: A Short Course* ,9th Ed., Houghton Mifflin Company, **1995**.
- 5 Brooks, K.K.; Hickmott, P.W.; Jutle, K.K.; Schreyer, C.A. *S. Afr. J. Chem.* **1992**, 45, 2
- 6 Kitagawa, K.; Mizobuchi, N.; Hama, T.; Hibi, T.; Konishi, R.; Futaki, S. *Chem.Pharm.Bull.* **1997**, 45, 1782 and references therein.
- 7 Geldenhuys, W.J.; Malan, S.F.; Bloomquist, J.R.; Marchand, A.P.; Van der Schyf, C.J. *Medicinal Research Reviews* **2005**, 25, 22-48.
- 8 Davis, W.L.; Grunert, R.R.; Haff, R.F.; McGrahen, J.W.; Neumayer, E.M.; Paulshock, M.; Watts, J.C.; Wood, T.R.; Hoffmann, E.C. *Science* **1964**, 862
9. Pederson, C.J. *J. Amer. Chem. Soc.* **1967**, 89, 2495.
10. Pederson, C.J. *J. Amer. Chem. Soc.* **1967**, 89, 7017.
11. Christensen, J.J.; Eatogh, D.J.; Izatt, R.M. *Chem. Rev.* **1974**, 74, 351.
12. Weber, E; Toner, J. L.; Goldberg, I.; Vogtle, F.; Laidler, D.A.; Stoddart, J.F.; Bartsch, R.A.; Liotta, C.L. in *Crown ethers and analogs*, Patai, S. Ed., John Wiley and Sons, New York, **1989**.
13. Cram, D.J. and Cram, J.M. in *Container molecules and their guests*, Stoddart, J.F. Ed., Royal Society of Chemistry, Cambridge, **1994**.
14. Lindoy, L.F. in *The chemistry of macrocyclic complexes*, Cambridge University Press, Cambridge, **1989**.
15. Hiraoka, M. in *Crown compounds: Their characteristics and applications*, Elsevier Scientific publishing company, New York, **1982**.
16. Dietrich, B.; Lehn, J.M.; Sauvage, J.P. *Tetrahedron Lett.* **1969**, 2885; Lehn, J.M.; Sauvage, J.P. *Chem. Commun.* **1971**, 440; Cheney, J.; Lehn, J.M. *ibid.* **1972**, 487.
17. Timko, J.M.; Moore, S.S.; Walba, D.M.; Hiberny, P.C.; Cram, D.J. *J. Am. Chem. Soc.* **1977**, 99, 4207.
18. Stoddart, J.F.; Wheatley, C.M. *Chem. Commun.* **1974**, 390.
19. Gokel, G.W.; Cram, D.J.; Liotta, C.L.; Harris, H.P.; Cook, F.L. *J. Org. Chem.* **1974**, 39, 2445.

-
20. Timko, J.M.; Cram, D.J. *J. Am. Chem. Soc.* **1974**, *96*, 7159.
 21. Frensch, K.; Vogtle, F. *Tetrahedron Lett.* **1975**, 2109.
 22. Fleisher, E.B. *Inorg. Chem.* **1962**, *1*, 493.
 23. Tabushi, I.; Sasaki, H.; Kuroda, Y. *J. Am. Chem. Soc.* **1976**, *98*, 5727.
 24. Pederson, C.J. *J. Org. Chem.* **1971**, *39*, 2351.
 25. Dietrich, B.; Lehn, J.M.; Sauvage, J.P. *Chem. Commun.* **1970**, 1055.
 26. Graf, E.; Lehn, J.M. *J. Am. Chem. Soc.* **1975**, *97*, 5022.
 27. Lehn, J.M.; Simon, J.; Wagner, *Angew. Chem., Int. Ed.* **1973**, *12*, 578.
 28. Masuyama, A.; Nakatsuji, Y.; Ikeda, I.; Okahara, M. *Tetrahedron Lett.* **1981**, *22*, 4665.
 29. Blasius, E.; Janzen, K.P. *Pure and Applied Chemistry*, **1982**, *54*, 2115.
 30. Dehmlow, E.V.; Dehmlow, S.S. in *Phase Transfer Catalysis*, 2nd Ed; Verlag Chemie GmbH, Weinheim; **1983**
 31. Tomoi, M.; Abe, O.; Ikeda, M.; Kihara, K.; Kakinchi, H. *Tetrahedron Lett.* **1978**, 3031
 32. Pugia, M.J.; Czech, A.; Czech, B.P.; Bartsch, R.A. *J. Org. Chem.* **1986**, *51*, 2945
 33. Landini, D.; Montanari, F.; Pirisi, F.M. *Chem. Commun.* **1974**, 879.
 34. Brunet, E.; Poveda, A.M.; Rabasco, D.; Oreja, E.; Font, L.M.; Singh Batra, M.; Rodriguez-Ubis, J.C. *Tetrahedron:Asymmetry* **1994**, *5*, 935-948
 35. Solomons, T.W.G. in *Organic Chemistry*; 5th Ed; John Wiley and Sons, New York; **1992**
 36. Matsuda, T.; Koida, K. *Bull. Chem. Soc. Japan* **1973**, *46*, 2259.
 37. March, J. in *Advanced Organic Chemistry*, 4th Ed, John Wiley and Sons, New York, **1992**.
 38. Aitken, R.A.; Kilényi, S.N. Editors of *Asymmetric Synthesis*, Blackie Academic & Professional, London, **1992**.
 39. Schurig, V.; Leyrer, U. *Tetrahedron: Asymmetry* **1990**, *12*, 865.
 40. Gassman, P.G.; Dygos, D.K.; Trent, J.E. *J. Am. Chem. Soc.* **1970**, *92*, 2084
 41. Coppola, G.M.; Schuster, H.F. in *Asymmetric Synthesis, Construction of Achiral Molecules Using Amino Acids*, John Wiley and Sons, New York, **1987**.
 42. Williams, R.M. in *Synthesis of Optically Pure α -Amino Acids*, Pergamon Press, Oxford, **1989**.
 43. *α -Amino Acid Synthesis*, Tetrahedron Symposium in Print, 33; O'Donnell, M.J. Ed.; *Tetrahedron*, **1988**, *44*, 5253.
 44. Walbroel, Y.; Wagner J. *J. Chromatogr., A* **1994**, *680*, 253.
 45. Walbroel Y., Wagner J. *J. Chromatogr., A* **1994**, *685*, 321.

-
46. Palmer, T. in *Understanding Enzymes*, 4th Ed, Prentice Hall, London, **1991**.
47. Halgas, J. in *Biocatalysts in Organic Synthesis. Studies in Organic Chemistry 46*, Elsevier, Amsterdam, **1992**.
48. Armstrong, D.W.; Zhou, Y.W. *J.Liq.Chromatogr., A* **1995**, 715, 143.
49. Marchand, A.P.; Chong, H.S.; Ganguly, B. *Tetrahedron: Asymmetry* **1999**, 10, 4965.
50. Dolling, U.H.; Davis, P.; Gabrowski, E.J.J. *J. Am. Chem. Soc.* **1984**, 106, 446.
51. Bakó, P.; Szöllősy, A.; Bombicz, P.; Tőke L. *Synlett.* **1997**, 291.
52. De Vries, E.F.J.; Ploeg, L.; Colao, M.; Brussee, J.; van der Gen, A. *Tetrahedron: Asymmetry* **1995**, 6, 1123.
53. Bakó, T.; Bakó, P.; Keglevich, K.; Bombicz, P.; Kubinyi, M.; Pál, K.; Bodor, S.; Makó, A.; Tőke L. *Tetrahedron: Asymmetry* **2004**, 15, 1589
54. Bakó, P.; Czinge, E.; Bakó, T.; Czugler, M.; Tőke L. *Tetrahedron: Asymmetry* **1999**, 10, 4539.

CHAPTER 2

ATTEMPTED SYNTHESIS OF TARTRATE-BASED MACROCYCLES

INTRODUCTION

The Pentacycloundecane (PCU) cage system lends itself to incorporation into crown ethers and macrocycles. As mentioned previously the cage skeleton offers a number of possible advantages to such macrocycles, especially with regards to enantioselectivity.¹ These include:

- a high degree of rigidity.
- ten extra chiral centres.
- increased solubility in non-polar solvents.
- clear differentiation between the two faces of the ligand.

The PCU cage is easily synthesised^{2,3} from readily available starting materials as shown below (Scheme 13).

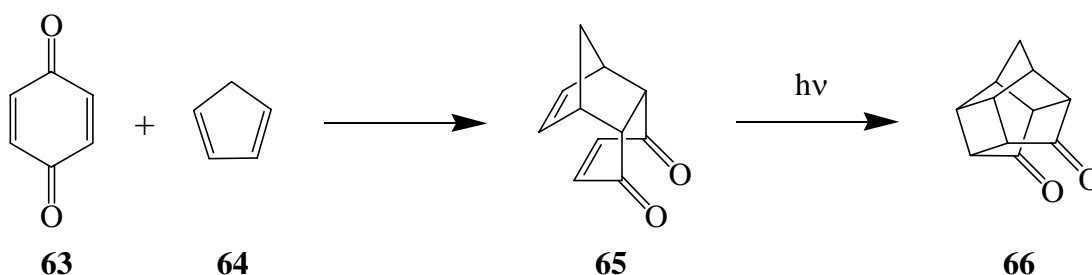

Scheme 13: Synthesis of Pentacyclo[5.4.0.0^{2,6}.0^{3,10}.0^{5,9}]undecane-8,11-dione

The Diels-Alder reaction ([4+2] cycloaddition) of *p*-benzoquinone (**63**) and cyclopentadiene (**64**) results in the adduct (**65**) which upon photolysis results in the PCU-8,11-dione (**66**).^{2,3} In our laboratory, the cage dione is then purified via soxhlet extraction with hexane. Marchand *et al.* have developed an effective method for incorporating the PCU cage into crown ethers.⁴ This method is illustrated in the synthesis of the achiral cage annulated crown ether (**70**) (Scheme 14).

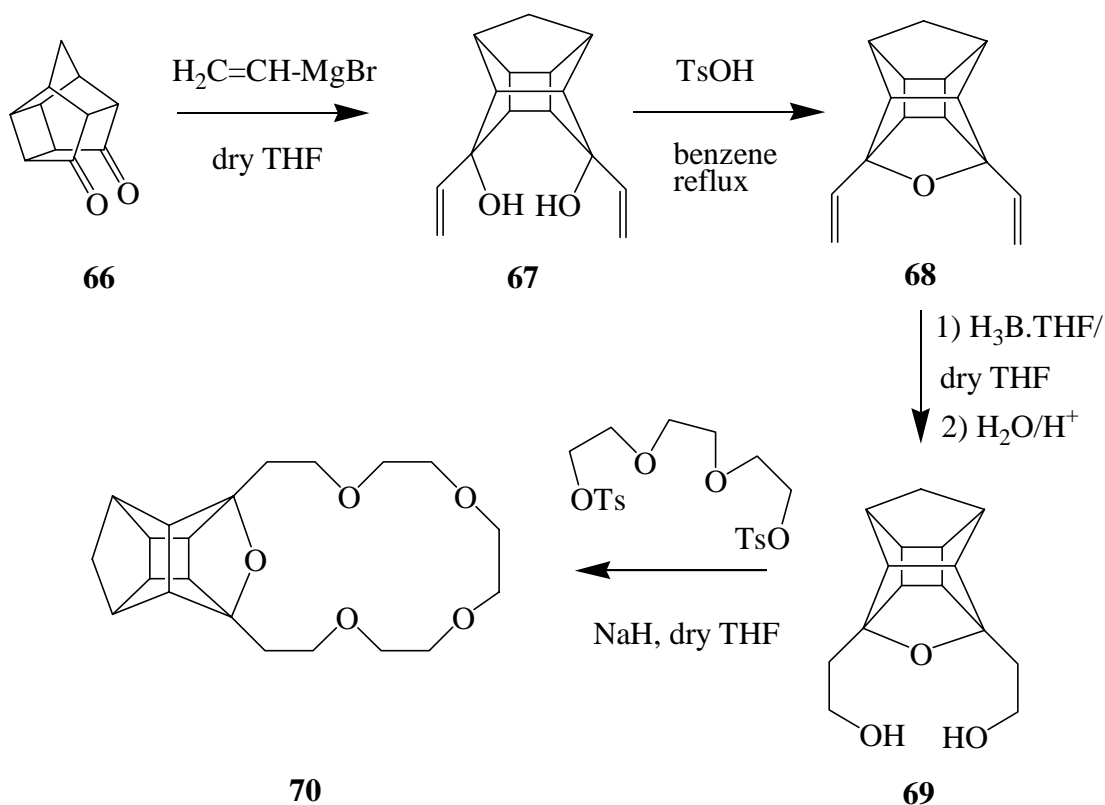

Scheme 14: Improved PCU crown ether synthesis

Cage annulated crowns such as (**70**) above have mostly been used in alkali picrate extraction studies while the first chiral cage annulated crown ether (**51**) synthesized by Marchand *et al.* has been used in transport studies using chiral ammonium salts.

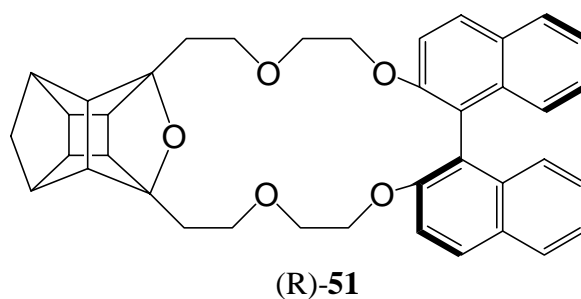

Macrocycles incorporating the PCU cage moiety were recently explored as catalysts in phase transfer reactions.⁵ It was therefore decided to continue with this application.

ASYMMETRIC CATALYSIS

Phase transfer catalysis using chiral crown ethers is one of the more recent techniques being used in asymmetric synthesis.^{6,7} Chiral carbon-carbon bond formation is a very active area of research. The Michael reaction is a good example of a carbon-carbon bond forming reaction.^{8,9,10,11} Due to the fact that this reaction often results in the formation of a stereogenic centre, much effort has been made to carry out the reaction in a stereoselective manner. Chiral crown ethers have been used as phase transfer catalysts in stereoselective Michael reactions⁷ with varying degrees of success. Some examples of the more successful crown ethers used for this reaction can be seen below along with their associated enantiomeric excess (*ee*) figures.¹²

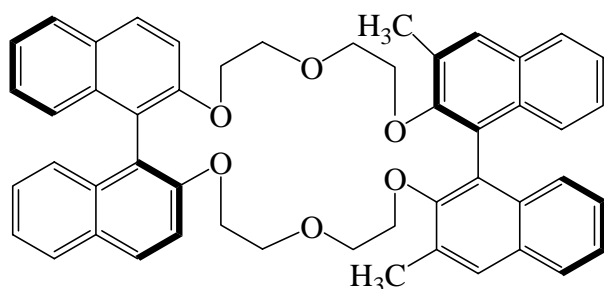

(*S,S*)-**71** (99% *ee*)

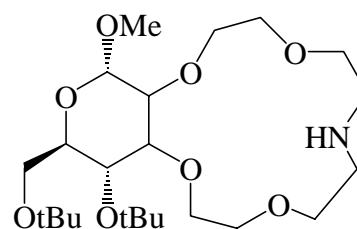

72 (90% *ee*)

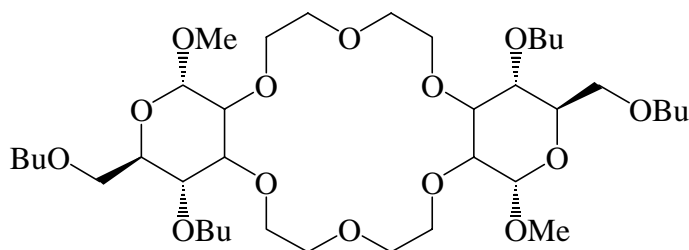

73 (84% *ee*)

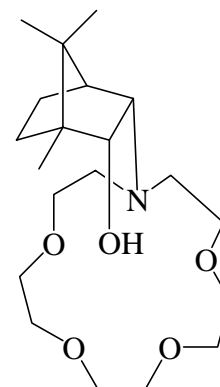

74 (83% *ee*)

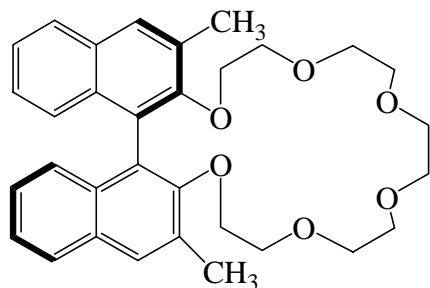
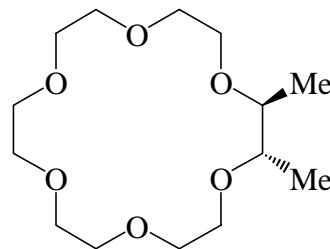
**(R)-75** (83% *ee*)**76** (79% *ee*)

The following scheme attempts to illustrate how enantioselectivity may arise in the classical Michael addition of methyl phenylacetate and methyl acrylate. The sodium base extracts a proton from the methyl phenylacetate to yield the carbanions (**77**). The sodium ion is complexed within the macrocycle to form the host-guest complex (**78**). This cation acts as the counter-ion to the carbanion.

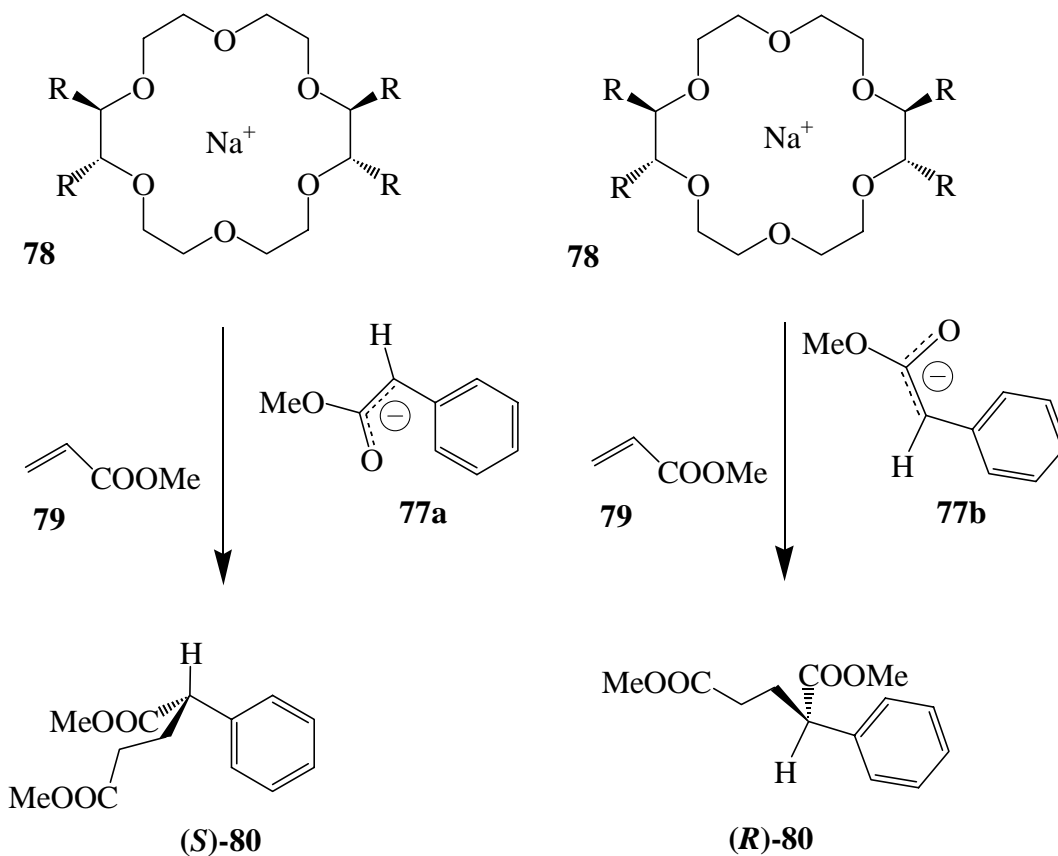
**Scheme 15:** Illustration of Michael Addition of methyl phenylacetate to methyl acrylate

In the above scheme the carbanion can be considered to be complexed above the macrocycle. Due to the chiral factors resulting from the R-groups of the macrocycle, the complexes induce enantiomeric selectivity in the products. In each example the lower energy complex will form more readily and will therefore be available in larger concentration for attack by the methyl acrylate (**79**). The resulting product will therefore form in excess.

PREVIOUS MICHAEL ADDITIONS USING CAGE ANNULATED MACROCYCLES

One of the most studied crown catalysed Michael additions is the classical Michael addition of methyl phenylacetate to methyl acrylate.

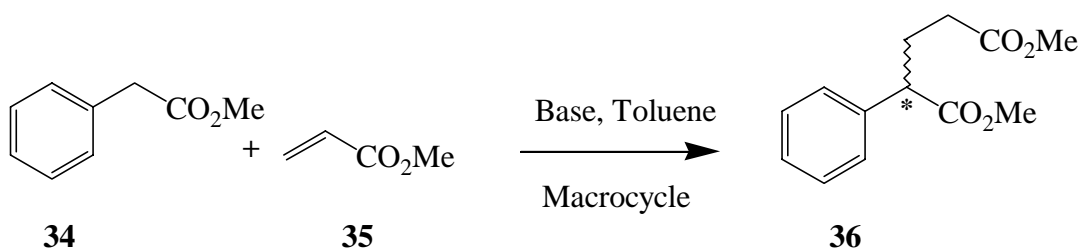

Scheme 16: Michael addition of methyl phenylacetate to methyl acrylate

This reaction has traditionally been catalysed by crown ethers with six donor atoms.^{13,14,15} The macrocycles are typically of the type 18-crown-6. The number of donor atoms, the position of the chiral influence and steric bulk of the macrocycle are all of importance insofar as determining the efficacy of the macrocycle as a catalyst.

As mentioned earlier, PCU annulated macrocycles have been used as catalysts in asymmetric Michael addition reactions. The only work reported to date was carried out employing cage annulated macrocycles derived from commercially available amino acids. The general structure of these catalysts can be seen below.

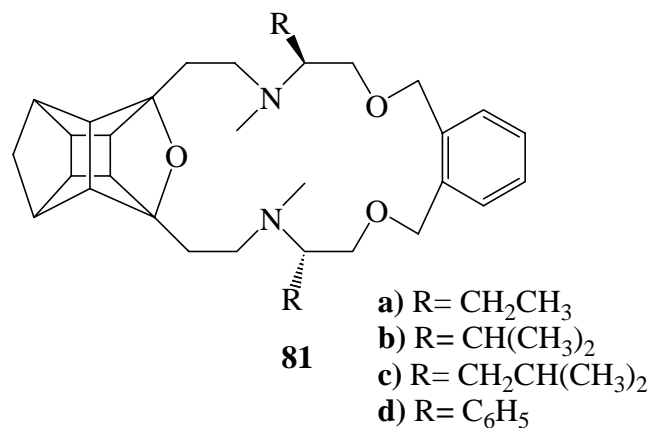

These macrocycles were tested as catalysts in two different Michael addition reactions. The classical Michael addition reaction of methyl phenylacetate to methyl acrylate was investigated. All attempts to catalyse this reaction using the PCU catalysts were unsuccessful as these catalysts are all five donor macrocycles (19-macrocycle-5). The other Michael addition reaction that was investigated was the Michael addition of 2-nitropropane to chalcone.

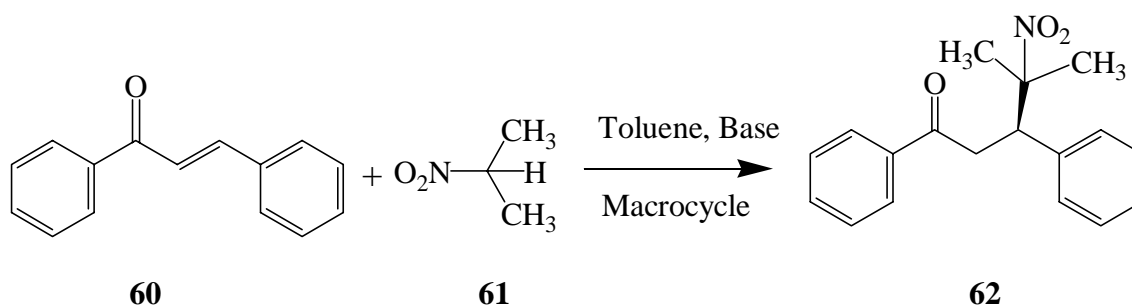

Scheme 17: Michael addition of 2-nitropropane to chalcone

This reaction has been successfully catalysed by macrocycles containing five donor atoms. Bakó *et al.* have been particularly active in this area using sugar derived crown ethers with some success.^{6,7,16,17,18} The PCU macrocycles used for this reaction also contained five donor atoms.

The results obtained from the testing of these catalysts using sodium methoxide as a base were very promising with respect to the enantiomeric excess obtained. For the macrocycles investigated the *ee* was found to be in the range from 80% to 92% depending on the macrocycle. These results compare favourably with the results obtained by other investigators.

In light of the results mentioned above it was decided to further pursue these reactions using a significantly different PCU derived macrocycle as the chiral catalyst.

SYNTHESIS OF MACROCYCLES

Marchand *et al*¹⁹ synthesized a series of five donor PCU annulated crown ethers incorporating optically active tartaric acid derivatives as the source of chirality. The general structure of these crown ethers can be seen below.

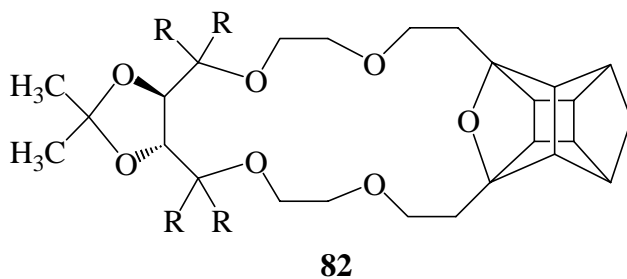

Marchand did not utilize these chiral crown ethers as catalysts. The general structure of these crown ethers could offer a unique opportunity to investigate what effect placing the source of chirality further from the cage would have on the efficacy of the macrocycle as a catalyst in Michael addition reactions. It was decided to synthesise a series of macrocycles similar to the above example incorporating amines similar to the macrocycles previously used as catalysts in Michael addition reactions. The general structure of the target macrocycles (**83**) is presented below in comparison to the previous PCU annulated macrocycles (**81**) used as catalysts.

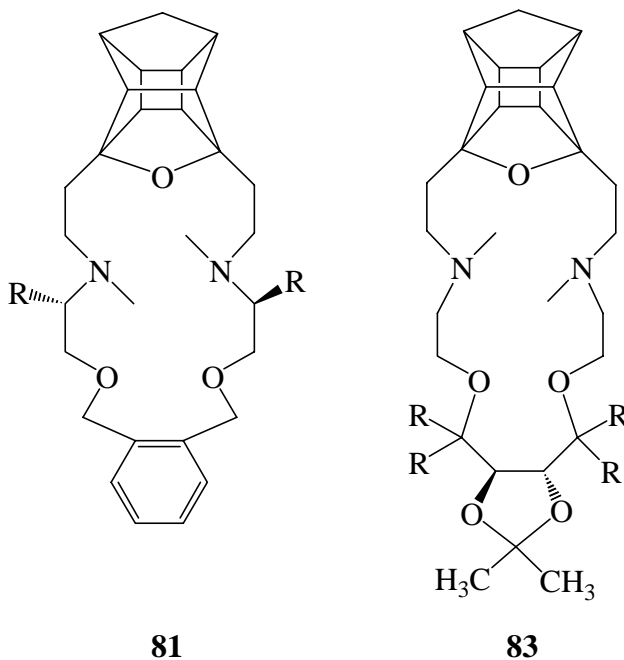

The cavity of the macrocycle (**83**) is much less sterically hindered in comparison to the previous macrocycles (**81**) used as catalysts in the asymmetric Michael addition reactions. As can be seen there are no longer any bulky substituents on the “side” of the cavity of the macrocycle that might interfere with the formation of the host-guest complex during the reaction. It was decided to attempt the synthesis of these hosts, as it will allow for the investigation of the effect of the three factors affecting the efficacy of the catalyst, namely, the number of donor atoms, the position of the chiral influence and steric bulk of the macrocycle.

ATTEMPTED SYNTHESIS OF MACROCYCLES

As with all PCU cage annulated crown ethers the starting material for the synthesis of these macrocycles is the PCU cage dione. A different procedure to the one shown in scheme 14 above was employed in the synthesis. The difference in the synthetic route used can be seen in the Scheme below.

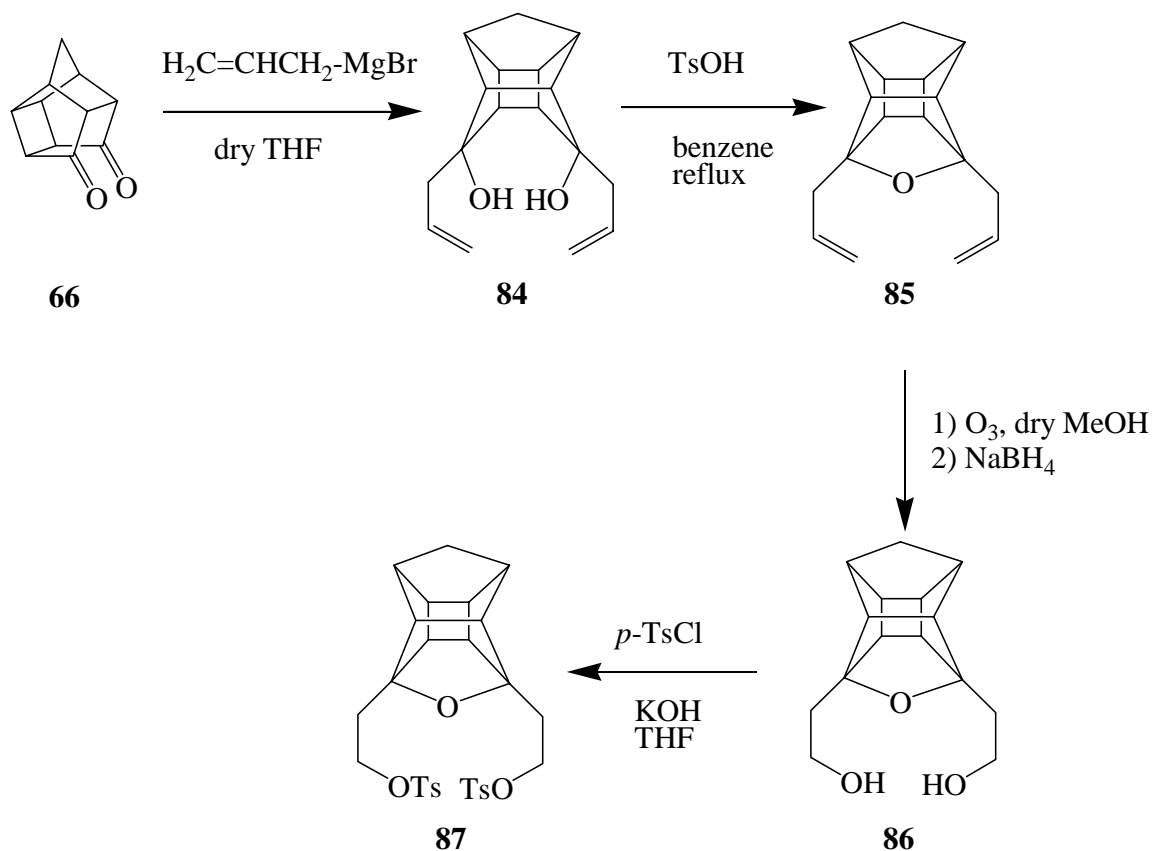

Scheme 18: Synthesis of PCU ditosylate (**87**)

The reaction of the PCU dione (**66**) with excess allylmagnesium bromide in dry THF afforded the corresponding PCU *endo-8-endo-11* diol (**84**).²⁰ The ¹H NMR spectrum showed an AB pattern at 1.45 and 1.83 ppm with a coupling constant of ~10 Hz which is indicative of the methylene bridge of the PCU cage. The ¹³C NMR spectrum showed a triplet at 117.5 ppm and a doublet at 134.4 ppm indicating the presence of the allyl groups and a singlet at 77.2 ppm for the quaternary carbons on the cage. Dehydration of this diol (**84**) yielded the corresponding hexacyclic ether (**85**). This is confirmed by the shift of the quaternary carbon signal from 77.2 ppm (for the precursor **84**) to 95.2 ppm. Ozonolysis of this hexacyclic ether followed by a reductive workup afforded the corresponding PCU diol (**86**). The ¹³C NMR spectrum showed a triplet at 34.4 ppm for the methylene attached to the cage and a triplet at 59.7 ppm for the methylene bonded to the OH group. The reaction of this diol (**86**) with *p*-toluenesulphonyl chloride in THF in the presence of solid potassium hydroxide afforded the PCU ditosylate (**87**). The ¹³C NMR spectrum showed a quartet at 21.6 ppm representing the methyl group of the tosyl moiety.

As mentioned above, the source of chirality in these new macrocycles is a derivative of tartaric acid. The general structure of the chiral unit can be seen below.

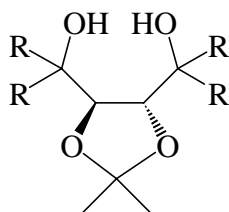

- 88:** R= H
89: R= CH₃
90: R= C₆H₅

The starting material for the synthesis of the above chiral diols (**88-90**) was dimethyl L-tartrate (**92**). This was reacted with 2,2-dimethoxy propane (**91**) with a catalytic amount of *p*-toluenesulphonic acid to yield the corresponding chiral ester (**93**).²¹ The reaction is presented in the scheme below.

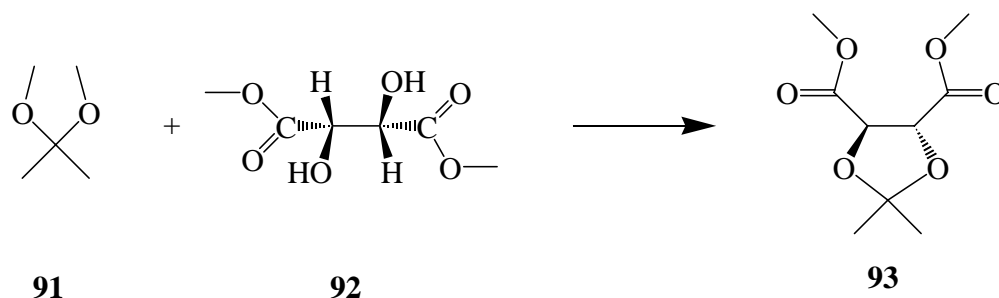

Scheme 19: Synthesis of methyl ester acetone (**93**)

The reaction mixture was purified by vacuum distillation to yield the product ester in good yield (88%). ^1H NMR analysis of the product showed three singlet signals. A singlet at 1.45 ppm representing the methyl groups, a methoxy singlet at 3.78 and a singlet at 4.75 ppm for the proton at the chiral centre. ^{13}C NMR showed a carbonyl signal at 170.1 ppm confirming the formation of the above product. This material was used as the starting material in the synthesis of all the above chiral diols (**88-90**). The optically active ester (**93**) above was reduced using LiAlH_4 in dry THF to yield the diol (**94**) as presented below.

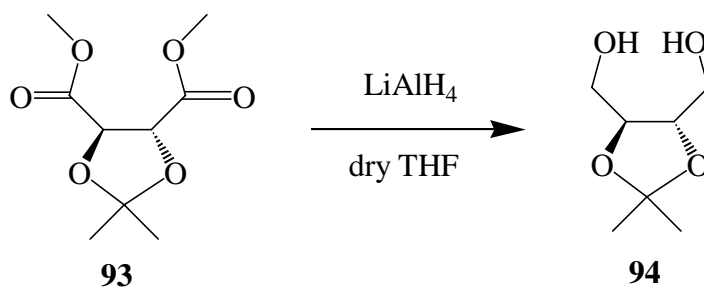

Scheme 20: Reduction of ester

^1H NMR shows a quartet at 3.7 ppm representing the methylene group attached to the hydroxyl groups. Also present is a broad peak at 2.7 ppm representing the hydroxyl protons. ^{13}C NMR shows a triplet peak at 62.1 ppm representing the methylene group. The remaining two optically active diols (**95-96**) were prepared by reaction with the corresponding Grignard reagents in dry THF as presented in the scheme below.²²

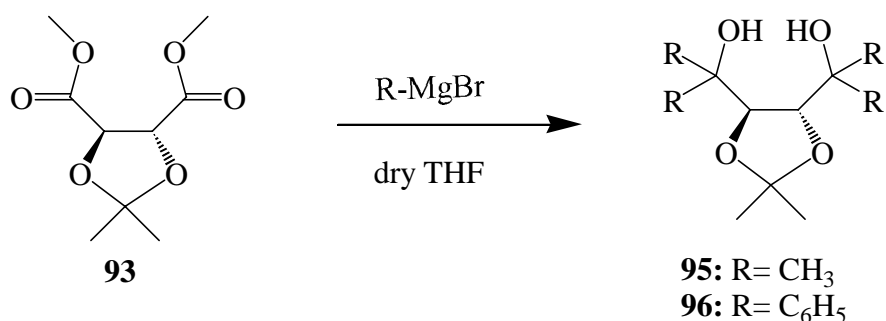

Scheme 21: Grignard reaction to form diols (**95**) and (**96**)

Due to the C₂ symmetry of these diols, one expects to see one peak for each of the R-groups on a specific side of the molecule as opposed to peaks splitting for each functionality on the molecule.

¹H NMR of the methyl derivative (**95**) showed three singlets between 1.2 and 1.4 ppm representing the three methyl groups in three different chemical environments (one signal for each of the two R-groups on each arm and one peak for the methyl groups from dimethoxy propane). The ¹³C NMR spectrum shows quartet peaks at 24.2 ppm, 27.4 ppm and 29.2 ppm representing the three methyl groups. A singlet at 85.2 ppm represents the quaternary carbon bonded to the hydroxyl group.

The structure of the phenyl derivative (**96**) was confirmed by the presence of a multiplet between 7.2 and 7.6 ppm representing the aromatic moieties. A singlet at 78.2 ppm in the ¹³C NMR APT spectrum represents the quaternary carbon attached to the hydroxyl group. Several aromatic doublets between 127.3 and 128.7 ppm can be seen as well as singlets at 142.7 and 145.9 ppm. The above data confirms the successful synthesis of both the methyl derivative (**95**) and the phenyl derivative (**96**) as shown in scheme 21.

Marchand *et al.* cyclized their macrocycles using the cage ditosylate as shown in scheme 22.

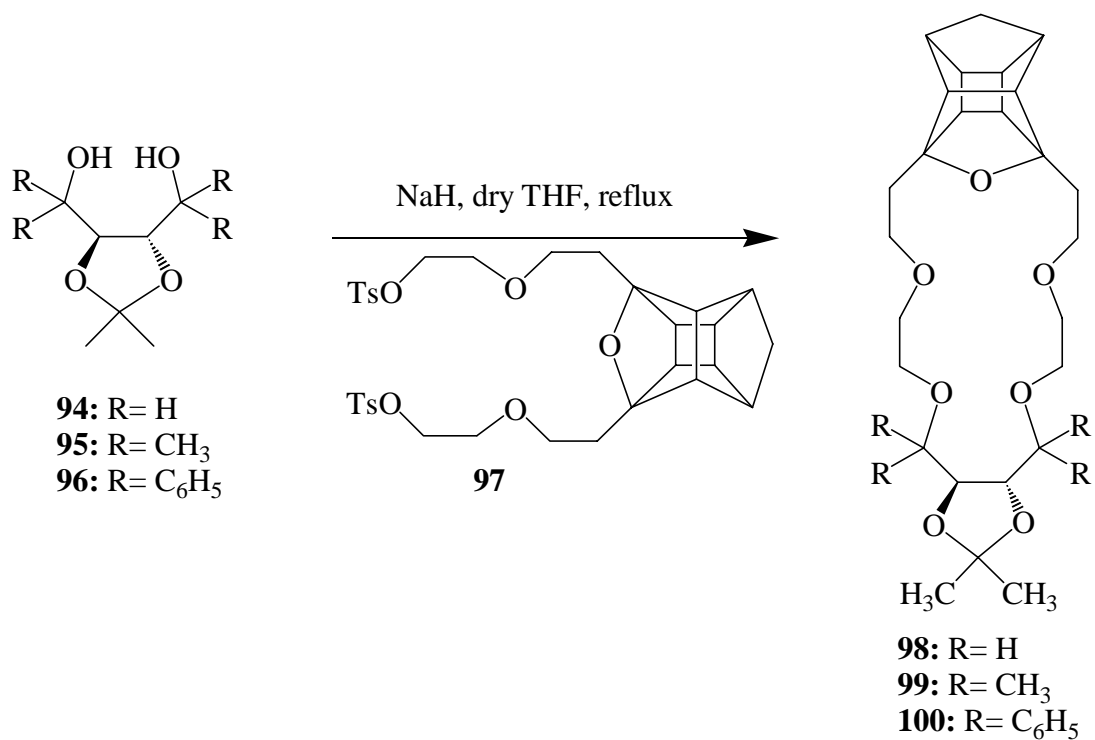

Scheme 22: Marchand's cyclization procedure

It was decided to use the same approach in order to synthesise the novel macrocycles.

The retrosynthesis of this intended approach can be seen in scheme 23. A possible drawback of this synthesis is the expected steric hinderance imposed by the bottom half of the macrocycles (structures **98-100**).

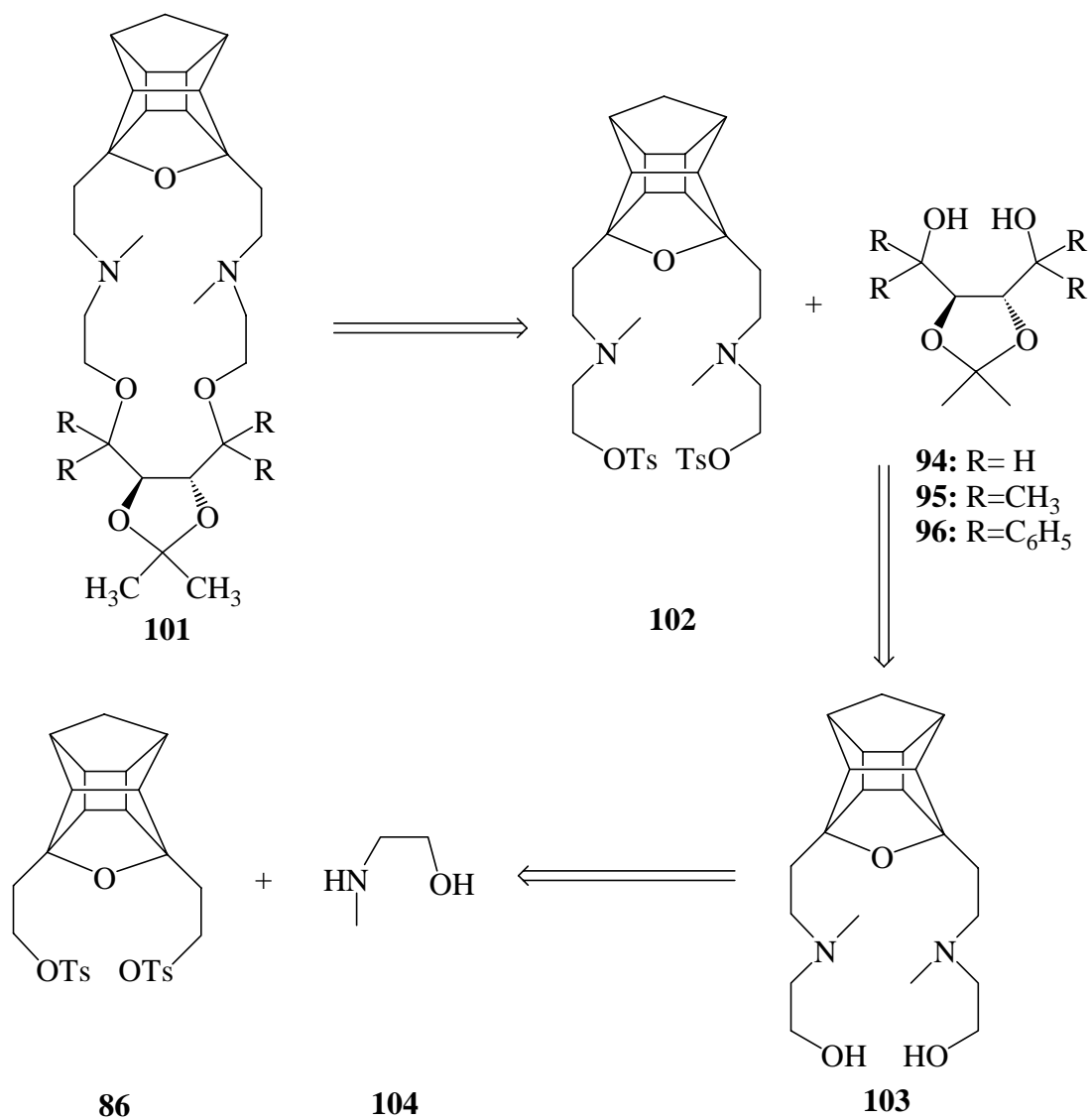

Scheme 23: Retrosynthetic pathway to macrocycle precursors

The starting material used was the cage ditosylate (**87**). The synthesis of this compound (**87**) was outlined above. The cage ditosylate was reacted with 2-(methylamino) ethanol (**104**) as shown in scheme 24.

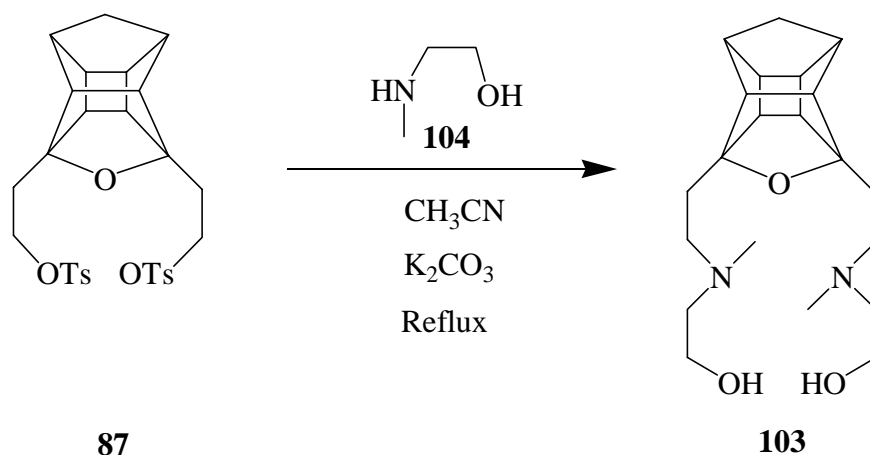

Scheme 24: Synthesis of novel cage amino diol (**103**)

The novel cage amino diol (**103**) above was isolated using column chromatography with chloroform, methanol and ammonium hydroxide (88:10:2) as eluents. ^1H NMR showed AB patterns at 1.45 and 1.83 ppm with a coupling constant of 10Hz as well as the characteristic multiplet from 2.15 to 2.60 ppm confirming the presence of the cage. ^{13}C NMR showed a triplet at ~43 ppm representing the methylene bridge of the cage as well as a peak at 30.9 ppm representing the N-methyl group. The IR spectrum showed a strong, broad hydroxyl peak at ~3400 cm^{-1} . This data confirms the successful synthesis of the novel diol (**103**) above.

The next step in the synthesis involved the addition of the tosyl leaving group. The diol (**103**) was reacted with toluenesulphonyl chloride in THF with KOH as the base. The reaction scheme is presented below.

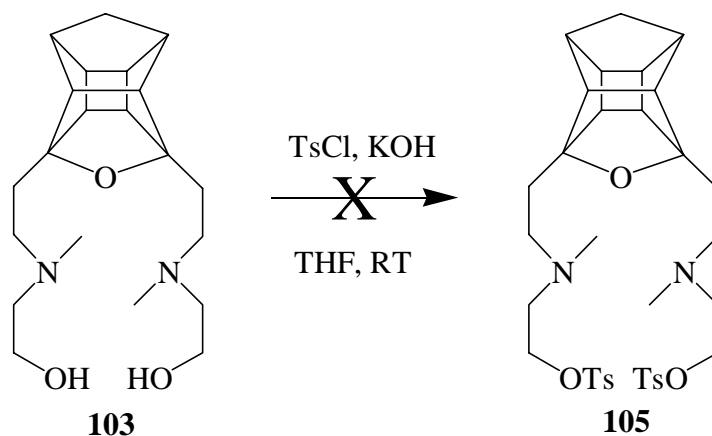

Scheme 25: Attempted synthesis of PCU-amino-ditosylate (**105**)

Upon workup, it became apparent that the above reaction had failed. Purification of the reaction mixture resulted in the recovery of a small amount of the starting material and the isolation of predominantly elimination products. It became apparent that another approach was required in order to add a leaving group to this material.

It was clear that any attempt to derivatise the hydroxyl groups to form leaving groups would fail. Another approach was required. A survey of the literature revealed a procedure where amino diols were reacted with thionyl chloride²³ to yield dichloro compounds. It was decided to attempt this reaction using the cage-amino-diol (**103**). The chloride groups would act as fairly efficient leaving groups in the cyclization reaction to yield the final macrocycle above. The reaction scheme below outlines the reaction carried out.

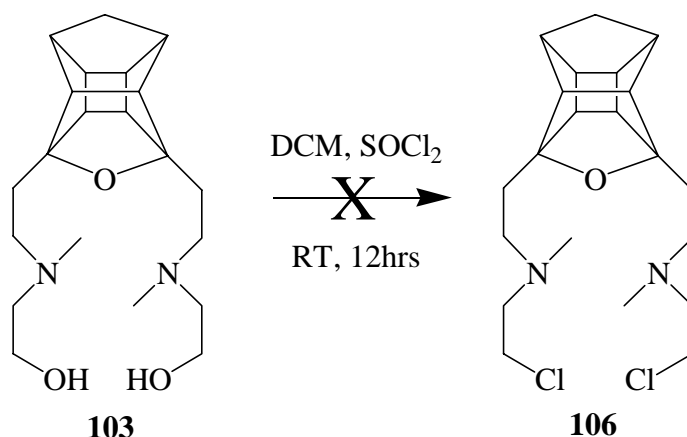

Scheme 26: Reaction of diol (**103**) with thionyl chloride

Workup again revealed that the reaction had failed to proceed as expected. Once again only starting material was recovered. The reaction was repeated at reflux with the same result. This result showed that further thought was necessary in order to obtain the required leaving groups.

It is known that reacting an alcohol with concentrated hydrobromic acid yields the corresponding bromide.^{24,25} The bromine group is considered to be a good leaving group. In light of the failures above, it was therefore decided to attempt to convert the hydroxyl groups to bromides by treating the diol (**103**) with concentrated HBr as shown in scheme 27.

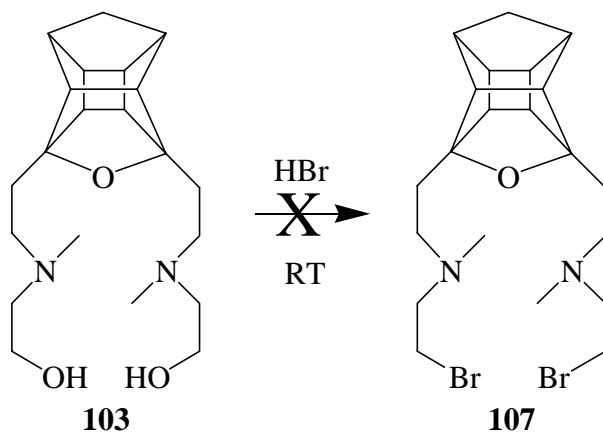

Scheme 27: Attempted bromination of the diol (**103**)

Once again it was found that no reaction had occurred. Only starting material was recovered on workup. This reaction was also repeated at reflux temperatures with the same result.

At this stage it was decided that attempting to derivatise the hydroxyl groups whilst attached to the cage would only lead to further failures. Therefore conversion of these groups before coupling to the cage ditosyl (**87**) seemed like a logical approach.

A survey of literature revealed a procedure in which amino alcohols are successfully converted to the corresponding hydrobromide salt.²⁶ It was decided to use this procedure starting with 2-(methylamino)ethanol (**104**) as outlined in the scheme below.

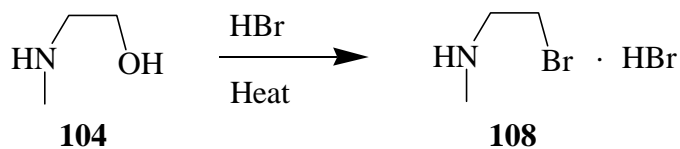

Scheme 28: Synthesis of hydrobromide salt (**108**)

The above synthesis of the hydrobromide salt (**108**) was successful. The product was obtained as a hygroscopic colourless solid after recrystallization of the reaction mixture from acetone. The IR spectrum confirmed the absence of the hydroxyl peak at $\sim 3400\text{ cm}^{-1}$.

All attempts to couple the hydrobromide salt onto the cage ditosyl failed. Only starting materials were recovered. It is believed this is due to the fact that the hydrobromide salt was fairly insoluble in acetonitrile.

It was decided at this stage to attempt the coupling of the hydrobromide salt (**108**) above to the optically active diol before coupling to the cage ditosyl. It was decided that the least sterically hindered diol (**94**) would be used for this reaction. The reaction scheme is presented below.

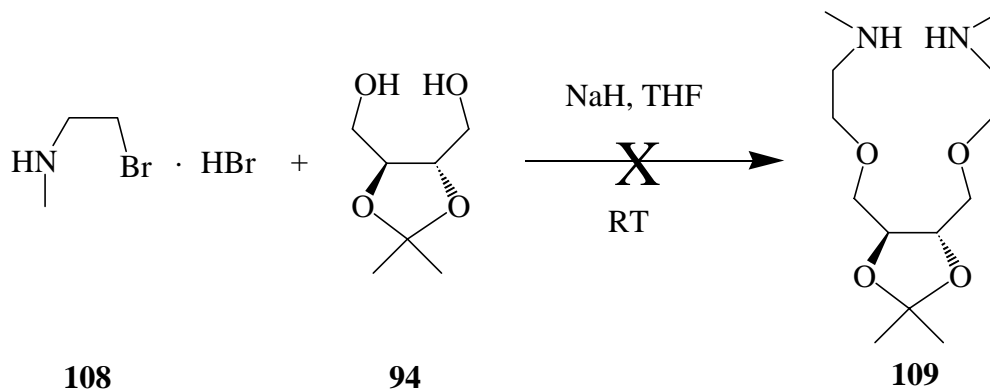

Scheme 29: Attempted coupling of hydrobromide salt (**108**) to chiral diol (**94**)

The above reaction was carried out at fairly low dilution. Upon workup, once again only starting materials were recovered. It was noted that the hydrobromide salt was only sparingly soluble in THF and it is suspected that this could be the reason for the reaction failing.

At this stage a fresh approach to the entire synthesis was required. All obvious approaches to the synthesis using the materials in hand had been exhausted. It was decided to pursue the “bottom up” approach to the synthesis where the molecule would be constructed starting with the chiral diols. This as opposed to the “top down” approach starting with the cage ditosylate. This “top down” approach had effectively been exhausted in terms of synthetic options. In the approach adopted it was envisaged that the diol would be reacted with an ethylene compound containing two leaving groups of differing lability. The resultant products (**110-112**) would then be reacted with methylamine to give the chiral diamine compounds (**113-115**) as shown in scheme 30.

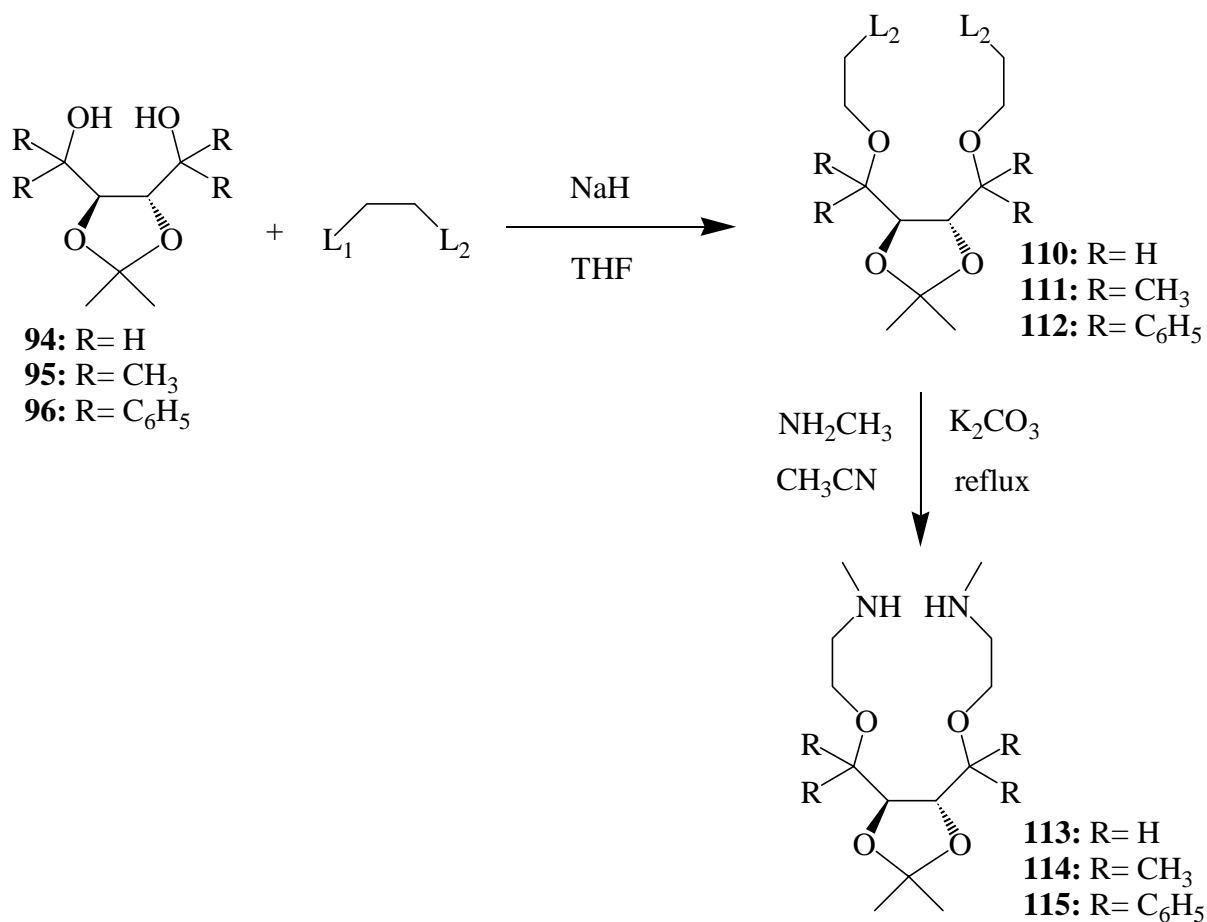

Scheme 30: Envisaged synthetic route to chiral diamine compounds (**113-115**)

In the scheme above L₁ and L₂ are leaving groups of differing lability such that L₁ is more labile than L₂ and hence will leave more readily in the initial coupling reaction as shown above. The first ethane derivative used in this attempted coupling was synthesized from 2-chloroethanol (**116**). This material was tosylated as shown in the scheme below.

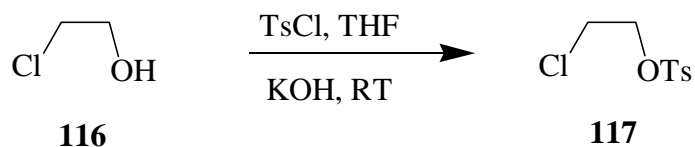

Scheme 31: Tosylation of 2-chloroethanol (**116**)

The reaction above was quantitative. ^1H NMR showed a methyl peak at 2.4 ppm as well as aromatic protons between 7.3 and 7.8 ppm. This confirmed the successful synthesis of the material (**117**) above. The tosyl leaving group being more labile than the chloro group. Two equivalents of the above material were reacted with the phenyl diol (**96**) as shown below.

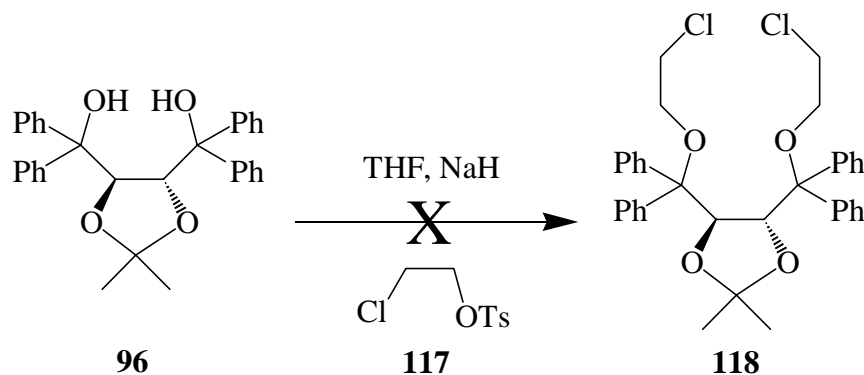

Scheme 32: Attempted coupling to the diol (**96**)

Upon workup, it was discovered that the reaction had failed. Only starting materials were recovered. The initial reaction was carried out at low dilution and at room temperature. It was decided to repeat the reaction at reflux temperatures. The result upon workup remained the same. It was suspected that the solvent was unable to stabilize the transition state. The reaction was therefore repeated using dimethylformamide as the solvent and CsCO_3 as the base.²⁷ The reaction was again carried out at room temperature and at reflux temperatures. The results remained the same with starting materials being isolated in both cases. Other bases such as Na_2CO_3 and K_2CO_3 and solvents such as acetonitrile were tried at different temperatures but to no avail. It was then decided to use more extreme conditions. The reaction was carried out in ethanol using solid KOH as the base. The reaction was carried out again at room temperature and at reflux. However, even these conditions failed to result in the desired reaction with starting materials being recovered once again. As a last resort, it was decided to repeat the reaction using a sealed reactor tube at elevated temperatures. The reaction was carried out in DMF with CsCO_3 as the base at a temperature of 100°C for two days. Again, no reaction occurred and starting materials were recovered. It is suspected that steric factors are responsible for the failure of the above reaction to proceed. The tosyl leaving group is fairly bulky as is the diol used in the reaction due to the four phenyl groups present near the region at which coupling is due to occur.

It was decided to use a different ethane compound in order to avoid this steric hinderance problem. It was decided to use 1-bromo-2-chloroethane (**119**). The bromide group is more labile than the chloride and will therefore, in theory, leave more easily. The reaction was carried out as shown in the reaction scheme below.

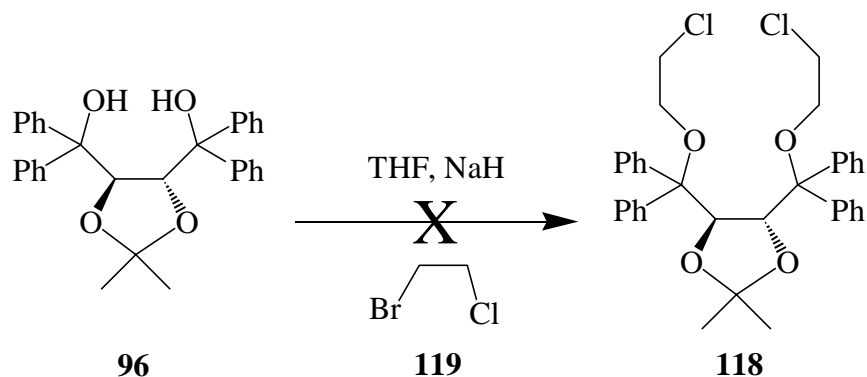

Scheme 33: Attempted coupling using 1-bromo-2-chloroethane (**119**)

The reaction above was carried out at low dilution and at room temperature. The reaction was tracked by thin layer chromatography (TLC). TLC showed that after 24 hrs the reaction had once again failed to proceed and that starting materials alone were present. The reaction was heated to reflux temperatures and left for a further 24 hrs. TLC again revealed that the starting materials were still present. This was confirmed by NMR on workup. The reaction was once again carried out using a variety of different solvents and bases as carried out previously. The result in every case was the same. Starting materials were recovered in every case.

CONCLUSION

All attempts to synthesise the new class of sugar based macrocycles failed. Considerable time and effort was invested in the attempts to synthesise these macrocycles. All the reactions carried out above were repeated several times in order to confirm the outcome. On every occasion the outcome was in fact the same. It is believed that most reasonable approaches to the synthesis above were investigated. The reason for the persistent failures remains unclear. Steric factors remain the most likely reason for this, although the reactions were repeated with the methyl functionalized diol (**95**), which is less sterically hindered, with the same result. A positive aspect of the poor overall result is that significant knowledge was gained in carrying out reactions of the type above, as well as experience in manipulating reaction conditions in order to achieve the

desired result. Another positive aspect is that a novel cage amino diol (**103**) was synthesised and characterized. Unfortunately, this compound was not chiral and therefore could not be used as a chiral catalyst on its own.

REFERENCES

- 1 Marchand, A.P.; Chong, H.S.; Ganguly, B. *Tetrahedron Asymmetry* **1999**, *10*, 4965.
- 2 Marchand, A.P.; Allen, R.W. *J. Org. Chem.* **1974**, *39*, 1596.
- 3 Cookson, R.C.; Grundwell, E.; Hill, R.R.; Hudec, J. *J. Chem. Soc.* **1964**, 3062.
- 4 Marchand, A.P.; Kumar, K.A.; Mckim, A.S. *Tetrahedron* **1997**, *53*, 3467.
- 5 Boyle, G.A.; Govender, T.; Kruger, H.G.; Maguire, G.E.M. *Tetrahedron: Asymmetry* **2004**, *15*, 3775.
- 6 Bakó, P.; Bajor, Z.; Töke L. *J. Chem. Soc., Perkin Trans 1* **1999**, 3651.
- 7 Bakó, P.; Czinge, E.; Bakó, T.; Czugler, M.; Töke L. *Tetrahedron: Asymmetry* **1999**, *10*, 4539.
- 8 Bergmann, E.D.; Ginsburg, D.; Pappo, R. *Org. React.* **1959**, *10*, 179.
- 9 Ihara, M.; Fukumoto, K. *Angew. Chem., Int. Ed. Engl.* **1993**, *32* 1010.
- 10 Krause, N.; Gerold, A. *Angew. Chem., Int. Ed. Engl.* **1997**, *36*, 186.
- 11 Krause, N.; Röder, A.H. *Synthesis* **2001**, *2*, 171.
- 12 O'Donnell, M.J. in *Catalytic Asymmetric Synthesis*, 2nd Ed; edited by Iwao Ojima; Wiley-VCH, Inc; **2000**.
- 13 Cram, D.J.; Sogah, G.D.Y. *J. Chem. Soc., Chem. Commun.* **1981**, 625.
- 14 Vicent, C.; Martin-Lomas, M.; Penadés, S. *Tetrahedron* **1989**, *45*, 3605.
- 15 Aoki, S.; Sasaki, S.; Koga, K. *Tetrahedron Letters* **1989**, *30*, 7229.
- 16 Bakó, P.; Novák, T.; Ludányi, K.; Pete, B.; Töke L.; Keglevich, G. *Tetrahedron: Asymmetry* **1999**, *10*, 2373.
- 17 Bakó, P.; Vizvárdi, K.; Toppet, S.; Van der Eycken, E.; Hooernaert, G.J.; Töke L. *Tetrahedron* **1998**, *54*, 14975.
- 18 Bakó, P.; Bakó, T.; Szöllösy, A.; Matyás, C.; Keglevich, G.; Töke L. *Tetrahedron: Asymmetry* **2002**, *13*, 203.
- 19 Marchand, A.P.; Takhi, M.; Kumar, V.S.; Krishnudu, K.; Ganguly, B. *Arkivoc* **2001**, part (iii), 13-21.
- 20 Marchand, A. P.; Huang, Z.; Chen, Z.; Hariprakash, H. K.; Namboothiri, I. N. N.; Brodbelt, J. S.; Reyzer, M. L. *J. Heterocyclic Chem.* **2001**, *38*, 1361.
- 21 Carmack, M.; Kelley, C.J. *J. Org. Chem.* **1968**, *33*, 2171-2173.
- 22 Matteson, D.S.; Beedle, B.C.; Kandil, A.A. *J. Org. Chem.* **1987**, *52*, 5034.
- 23 Chartres, J.D.; Groth, A.M.; Lindoy, L.F.; Lowe, M.P.; Meehan, G.V. *J. Chem. Soc. Perkin Trans. 1* **2000**, *20*, 3444-3450.

-
- 24 Hart, H; Craine, D.J.; Hart , L.E. in *Organic Chemistry: A Short Course* ,9th Ed., Houghton Mifflin Company, **1995**.
- 25 Morrison, R.T.; Boyd, R.N. in *Organic Chemistry*, 6th Ed, Prentice-Hall Inc., New Jersey, **1992**.
- 26 Cortese, F. in *Organic Syntheses*, Collective Volume 2, **1950**, p 91,John Wiley & Sons Inc.
- 27 Private communication with Dr H.G. Kruger and Dr G.E.M. Maguire, supervisor and co-supervisor.

CHAPTER 3

SYNTHESIS OF CHIRAL CAGE ANNULATED MACROCYCLES

INTRODUCTION

As a result of the failure to synthesise the sugar based PCU annulated macrocycles (Chapter 2) it was decided to go back to basics and synthesise a similar macrocycle to the one previously reported as a successful chiral catalyst in Michael addition reactions.¹ The purpose of this was to investigate what effect a subtle change in the structure of the macrocycle would have on its efficacy as a catalyst. The general structure of the previously successful system is again shown below.

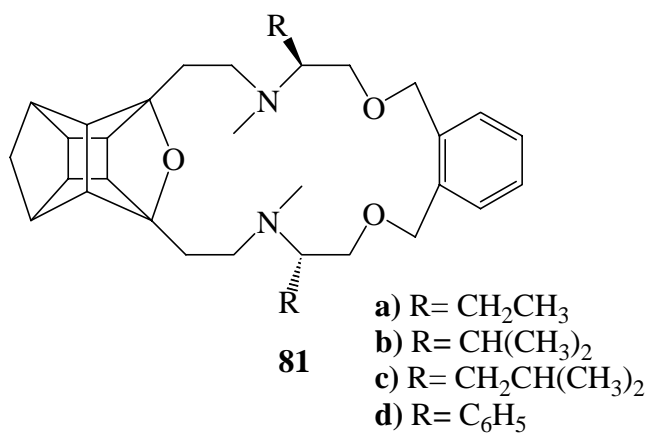

SYNTHESIS OF MACROCYCLES

It was decided to use a macrocycle that was only slightly different to the catalysts used before. The position of the chiral moieties as well as the steric bulk were left unchanged but the number of donor atoms was increased to six. This also increased ring size slightly. The general structure of the macrocycle decided upon (**120**) is presented below compared to the previous system (**81**).

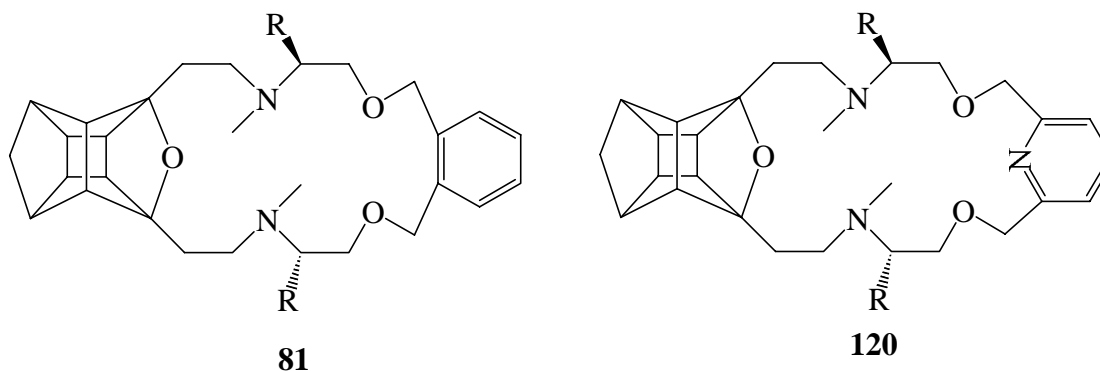

This new system could potentially be very useful for investigating what effect a variation in only one parameter, namely the number of donor atoms, would have on the efficacy of the catalyst in terms of chemical yield and enantioselectivity.

As mentioned the source of chirality for these macrocycles is commercially available amino acids. The amino acids leucine **121** and phenylglycine **122** were converted to their corresponding amino alcohols using the reactions outlined in the scheme below.

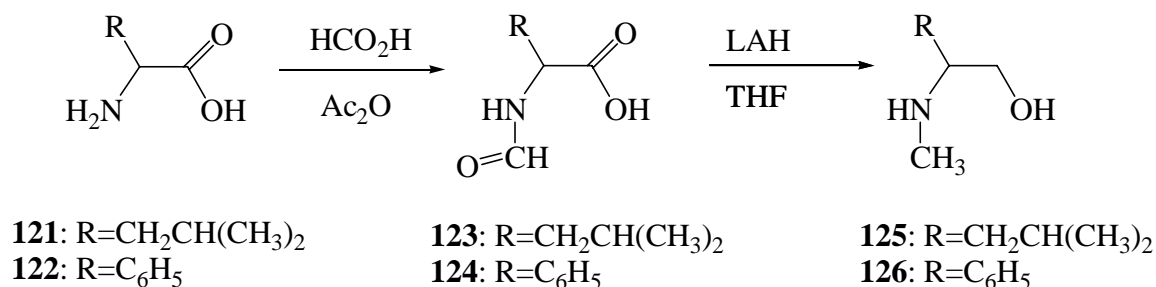

Scheme 34: Synthesis of N-methyl amino alcohols (**125-126**)

The amino acid starting materials were treated with acetic anhydride and formic acid to yield the respective formamides (**123-124**).^{2,3,4} The formamides were then reduced using LiAlH₄ at room temperature to yield the corresponding N-methyl amino alcohols (**125-126**). The N-methyl amino alcohols were used to eliminate the possibility of exchangeable protons quenching the base used in the catalytic reactions.

The reaction of the PCU-ditosylate with the amino alcohols (**125-126**) above in the presence of a mild base⁵ yielded the chiral PCU-amino diol ligands (**127-128**) as shown in scheme 35.

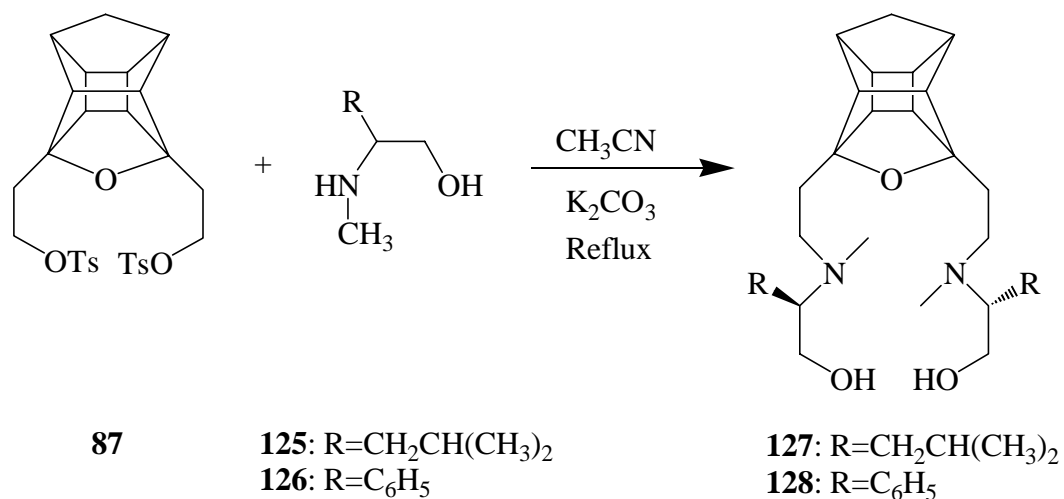

Scheme 35: Synthesis of PCU-amino-diol ligands (**127-128**)

The ¹H NMR showed the AB patterns at 1.45 and 1.83 ppm with a coupling constant of 10Hz as well as a multiplet from 2.15 to 2.70 ppm. These patterns are characteristic of the cage. The IR spectra of both ligands had a strong broad hydroxyl peak at ~3400cm⁻¹ as well as N-C stretching peaks at ~1200 cm⁻¹. This data confirmed the successful synthesis of the ligands (**127-128**) above.

These chiral ligands can themselves be used as chiral catalysts. Boyle *et al.*⁶ have used similar ligands with some success as catalysts in the reaction of diethylzinc with benzaldehyde. Chemical yields for this reaction varied from 60-92% and enantiomeric excess from 10-90%.

The reaction of the above PCU-amino-diol ligands (**127-128**) with 2,6-bis(bromomethyl)pyridine **129** and sodium hydride in dry THF afforded the desired novel macrocycles (**130-131**). The reaction is presented in scheme 36.

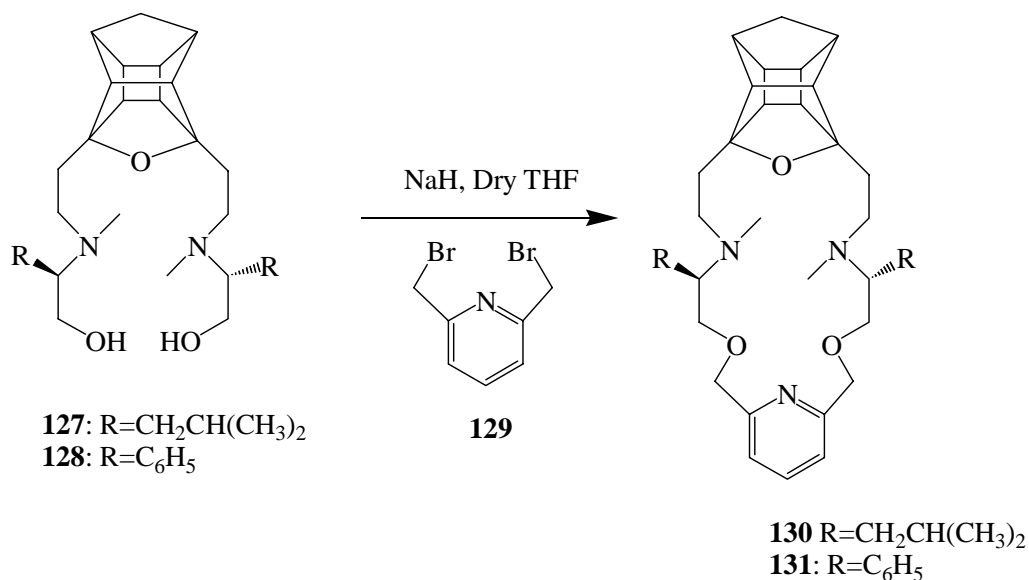

Scheme 36: Synthesis of novel PCU annulated macrocycles (**130-131**)

The macrocycles (**130-131**) were isolated using column chromatography with chloroform, methanol and ammonium hydroxide (88:10:2) as eluent. The NH₄OH was used in order to minimise the streaking of the product on the column. This streaking is common with amine compounds. The ¹H NMR spectrum again confirmed the presence of the cage with the characteristic AB pattern at 1.45 and 1.83 ppm. The presence of a peak at ~4.5 ppm confirmed the presence of the CH₂ attached to the pyridine and a triplet at ~7.7 ppm characteristic of the pyridine unit confirmed the successful synthesis of the macrocycles (**130-131**) above. The ¹³C NMR spectra of both macrocycles showed the quartet peak at ~95 ppm that is characteristic of the quaternary carbon on the cage. Also present in the spectra is a quartet peak at ~158 ppm representing the quaternary carbon bonded to the nitrogen of the pyridine unit. The IR spectra indicate the absence of the hydroxyl peak at ~3500 cm⁻¹. Mass spectrometry confirmed the [1:1] cyclization products with m/z peaks supporting the respective formulae.

RESULTS AND DISCUSSION

In light of the previous failures in the testing of cage annulated macrocycles in the Michael addition of methyl phenylacetate to methyl acrylate, it was decided to first test the crowns as catalysts in the reaction that had previously been successfully catalysed by PCU macrocycles, namely the Michael addition of 2-nitropropane to chalcone as shown in scheme 17. The results of these tests can be seen in the table below compared to the previous system **81**.

Table 1: Michael addition reaction of 2-nitropropane (**61**) and chalcone (**60**) catalysed by sodium methoxide and macrocycles (**130-131**) at 25°C

	Host				
	None	18-C-6	130	131	81b
Base	NaOMe	NaOMe	NaOMe	NaOMe	NaOMe
[host]/ mmol	none	0.05	0.05	0.05	0.05
[base]/ mmol	0.5	0.05	0.05	0.05	0.05
Time/ hrs	48	48	120	120	120
Yield %	0	52	12	12	12
<i>ee</i> / %	0	0	5	0	92

The testing was carried out using the procedure outlined by Boyle *et al.*¹ The control run was carried out without any host and no reaction was seen to occur. A second control reaction using dibenzo-18-crown-6 was carried out and a yield of 52 % was achieved in 48 hours. The product was racemic in nature as expected. Testing of the chiral hosts (**130-131**) was carried out over 120 hours. The reaction was monitored using thin layer chromatography. It was noted that only product and starting material were present in the reaction. No by-products were observed. The product was isolated using preparative TLC and the enantioselectivity determined by polarimetry. It was discovered that in initial tests where excess base was used, the product for both hosts was racemic. In subsequent tests using stoichiometric amounts of host and base, the product for host (**130**) exhibited low selectivity for the *S*-enantiomer (5% *ee*). The product for host (**131**) remained racemic. The chemical yields obtained were similar to that previously reported with the five donor atom PCU macrocycles. It therefore appears as if the chiral barriers of the new system (**120**) are less effective than the previous system (**81**). It was thought that the use of sodium, which is better suited to five donor crowns, may have contributed to the poor results. Due to the fact that the macrocycles contain six donor groups, it was decided to test them with a potassium base. The reactions were repeated using potassium *t*-butoxide, which is the standard base used in these types of reactions. The results of these reactions can be seen in Table 2 compared to the results from the previous successful investigation.

Table 2: Comparison of results obtained with different bases in the Michael addition reaction of 2-nitropropane (**61**) and chalcone (**60**).

	NaOMe	KOBu ^t	No. of Donor Atoms
18-Crown-6	52	56	6
81b Yield/ %	12	-	5
% <i>ee</i> for 81b	92	-	5
130 Yield/ %	12	12	6
% <i>ee</i> for 130	5	~ 5	6
131 Yield/ %	12	12	6
% <i>ee</i> for 131	0	~ 0	6

As can be seen the results for the chiral hosts were similar to those achieved using the sodium base in terms of chemical yield and enantiomeric excess. The control reaction with 18-crown-6 gave a slightly higher chemical yield (56 %) and the product was racemic as expected. It is also apparent that the host, and not the base, is responsible for the significant discrepancy in the selectivity of the reaction as compared to the previous investigation using PCU systems.

CONCLUSION

A new class of chiral cage annulated macrocycles was successfully synthesised. The chiral hosts were tested as phase transfer catalysts in the Michael addition of 2-nitropropane to chalcone using the procedure established by Boyle *et al.* The reaction was successfully catalysed by the hosts using sodium methoxide as the base. The chemical yield was low (12 %) as was the enantioselectivity (5 % *ee*). A repeat reaction using potassium *t*-butoxide as the base yielded similar results. The only parameter changed compared to the previous catalysts was the number of donor atoms in the ring. The effect of changing this parameter is clearly quite dramatic with respect to the enantioselectivity obtained. This increase in the number of donor atoms in the host resulted in a major difference in the selectivity but no change in chemical yield compared to **81b**. This indicates that the reaction is still proceeding as before but the chiral influence is not as pronounced. It is proposed that the increase in donor atoms and the related increase in ring size resulted in a shift of the site of the reaction further away from the chiral influence towards the pyridine ring. This would result in the chiral induction being significantly reduced resulting in the lower selectivity observed. It appears as though the Michael addition of 2-nitropropane to chalcone is most successfully catalysed by hosts containing five donor atoms. Further investigation using both computational and synthetic methods is required in order to obtain a better understanding of these systems and the reasons for the poor selectivity in the above

mentioned reaction. Insufficient chiral host remained after the testing carried out above to investigate the Michael addition of methyl phenylacetate to methyl acrylate.

REFERENCES

- 1 Boyle, G.A.; Govender, T.; Kruger, H.G.; Maguire, G.E.M. *Tetrahedron: Asymmetry* **2004**, *15*, 3775.
- 2 Muramatsu, I. *Bull. Chem. Soc. Jap.* **1965**; 244.
- 3 Aitali, M.; Allaoud, S.; Karim, A.; Meliet, C.; Mortreux, A. *Tetrahedron:Asymmetry* **2000**, *11*, 1367.
- 4 Huszthy, P.; Oue, M.; Bradshaw, J.S.; Zhu, C.Y.; Wang, T. *J.Org.Chem.* **1992**, *57*, 5383.
- 5 Marchand, A. P.; McKim, A. S.; Kumar, K. A. *Tetrahedron* **1998**, 13421.
- 6 Boyle, G.A.; Govender, T.; Kruger, H.G.; Maguire, G.E.M. *Tetrahedron:Asymmetry* **2004**, *15*, 2661.

CHAPTER 4

ATTEMPTED SYNTHESIS OF A CHIRAL FLUORESCENT SENSOR

INTRODUCTION

Fluorescence is a form of radiative decay where an excited molecule discards its excitation energy in the form of a photon of light.¹ After the initial absorption of energy, the molecule will lose some of its excitation energy non-radiatively by collisions with other surrounding molecules. In so doing it steps down the ladder of vibrational levels to the lowest vibrational level of an electronically excited state. If the surrounding molecules are unable to absorb enough energy to return the molecule to the ground state the remaining energy can be emitted as radiation. Most molecules do not fluoresce at room temperatures. The fluorescence emission when it does occur can often be seen in the visible region of the electromagnetic spectrum. This process is depicted in the energy level diagram below.

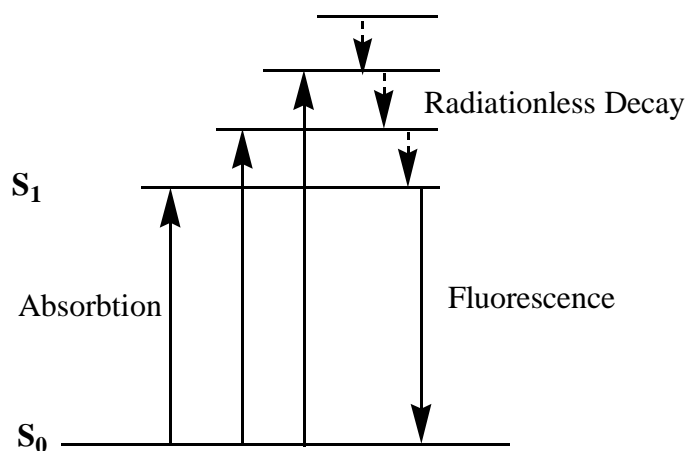

Figure 1: Diagram depicting the process of fluorescence

Fluorescence in organic chemistry is commonly found in conjugated organic molecules. The HOMO and LUMO energy levels of these delocalized systems lend themselves to electronic transitions with corresponding frequencies in the UV part of the electromagnetic spectrum. The emission thus tends to be Stoke shifted into the visible of the spectrum. This light phenomenon has been employed by researchers as a means to relay or signal information about specific

molecular events.² In order to examine these microscopic environments molecules with good fluorescent characteristics were designed to act as molecular devices. The term molecular sensors was coined and it describes the design, synthesis and analysis of simple molecules that are capable of rendering information (usually by optical means) about any molecular event *e.g.* a host-guest interaction or some binding event. Organic molecules themselves are very useful in that they can be purpose-built for any of these particular roles. The detection of ions in solution at low concentrations or in sub-cellular domains was an early example of these attempts at constructing such single molecule sensors.³

An example of one design that uses fluorescence as the signaling medium is the Photoinduced Electron Transfer (PET) system. PET systems have been the subject of much research over the past three decades. These systems consist of three distinct components, namely the fluorophore, the spacer and the receptor. The receptor is responsible for guest complexation and decomplexation. The fluorophore is the site of both photonic transitions of excitation and emission. The spacer hold the two above components close to, but separate from, each other. The PET event is essentially a redox reaction. Upon excitation of the molecule the receptor, (not being complexed) is oxidized and an electron transfer through space to the fluorophore occurs. In this situation the system is in the “off” state and no fluorescence is observed. This can be seen in the following model.^{2,4}

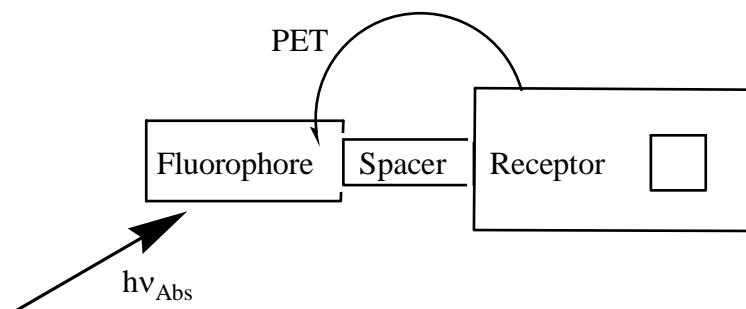

Figure 2: Schematic showing Receptor-Fluorophore system in the “off” state

In the above the thermodynamic condition for PET the excited state energy of the fluorophore must be high enough to oxidize the receptor and reduce the fluorophore. This can be illustrated in the orbital energy diagram (Figure 3).

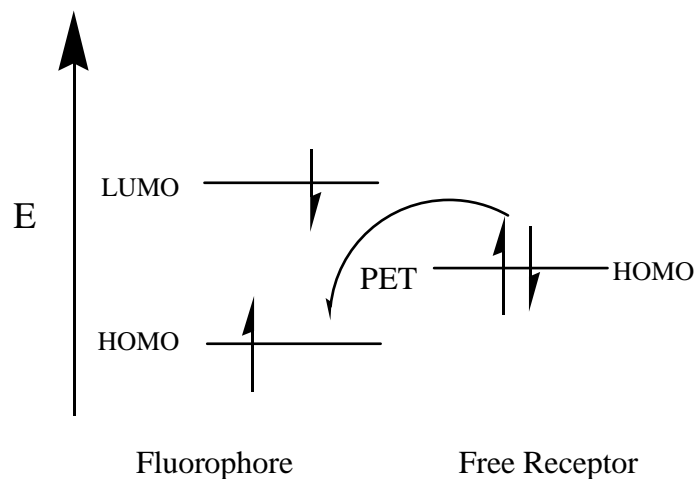

Figure 3: Orbital energy diagram depicting PET

However, when the receptor is complexed, the oxidation potential of the receptor is raised preventing loss of electrons and PET becomes thermodynamically disfavored. In these conditions the system is in the “on” state and fluorescence is observed. This is depicted in figure 4 below.

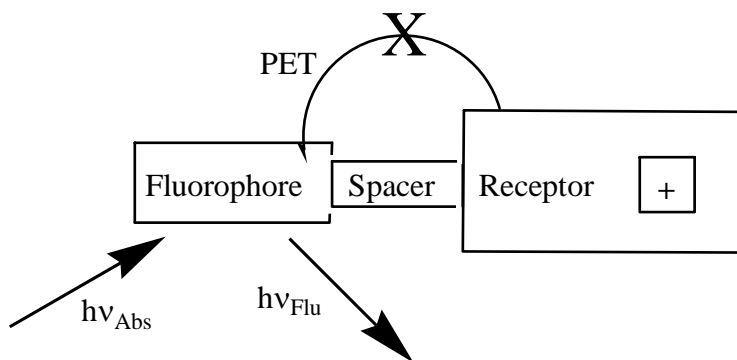

Figure 4: Receptor-Fluorophore system in the “on” state

The orbital energy diagram depicting this state is presented in Figure 5.

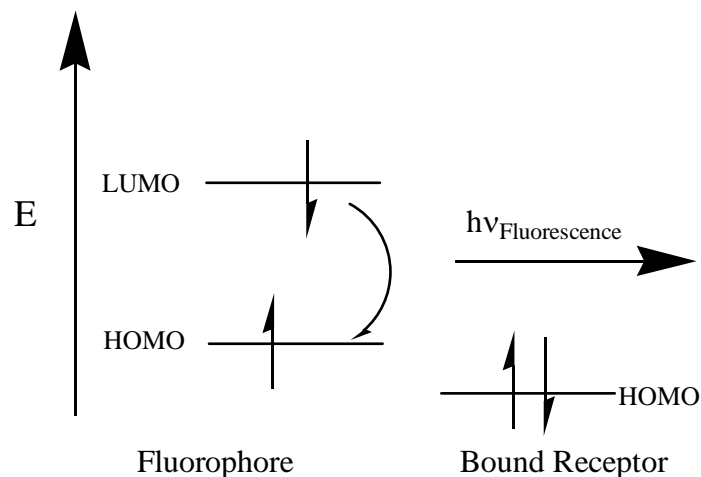
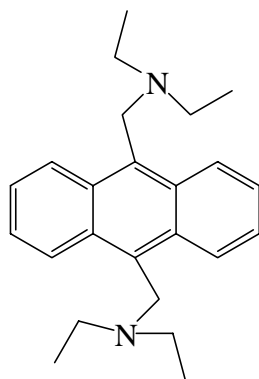
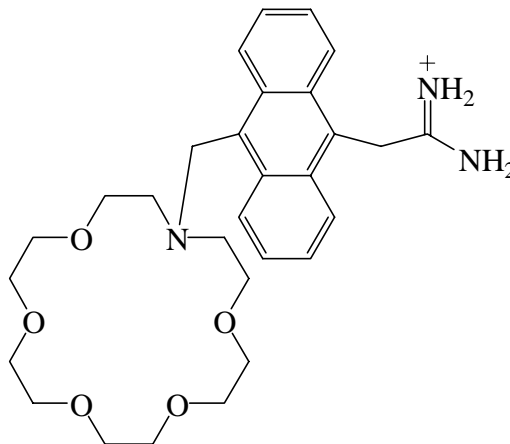

Figure 5: Orbital energy diagram depicting the “on” state

PET sensors were designed to take advantage of this “off” – “on” mechanism. In particular, the key was to create a situation where the primary sensing event coincided with the alteration of the receptor's electron oxidation potential.

Many PET systems have been designed over the years. These range from simple non-cyclic phenylalkylamines to more complex cyclic systems incorporating crown ethers and cryptands. These systems have been designed for a range of target ions and molecules. Several examples of pH sensors can be found in literature.^{5,6,7,8} One such case is illustrated below. In the molecule **132** the “lone pair” of the sp^3 hybridized nitrogen provides the “receptor” for the protons. As the pH is lowered towards the pK_a of the “lone pair” the electrons become protonated and the PET process ceases to occur. This leads to the “on” switch whereby fluorescence is released over a specific pH range. Other systems have been designed to target cations such as the alkali and alkali earth metals, ammonium ions and even some transition metal species. Many of these systems incorporate crown ethers.^{9,10} An example of one of these sensors can be seen below.^{2,4}

**132****133**

Compound **133** has demonstrated selective sensing for the neurotransmitter gamma-aminobutyric acid (GABA) in an aqueous methanol environment.¹¹ The crown ether provides the ammonium “receptor” part of the molecule.

From a literature survey it appears that none of the existing PET molecular devices have reported being capable of enantiomerically sensing ammonium ions. It was therefore decided to attempt the synthesis of a PET sensor that was chiral for use as a sensor for this purpose. For reasons of synthetic simplicity it was decided that when designing the chiral PET sensor to base it on a chiral ligand for which the synthetic procedure was well established. It was decided to derive the macrocycle from the chiral PCU amino diols synthesised previously in our group.¹² As a result the proposed target macrocycle **134** would have the structure shown below.

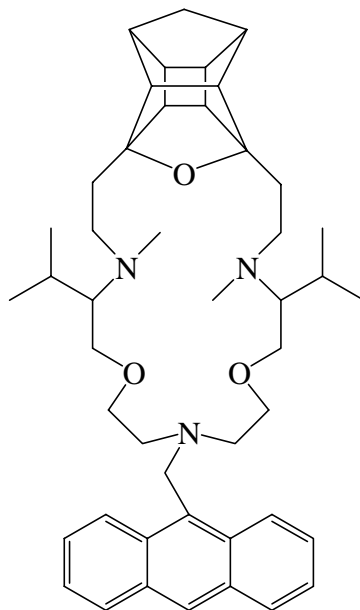
**134**

It was hoped that the proposed chiral PET sensor **134** above would be a fluorescent sensor capable of exhibiting selective complexation to one enantiomeric target over the other.

RESULTS AND DISCUSSION

The retrosynthetic approach to the synthesis of the target macrocycle is outlined in scheme 37.

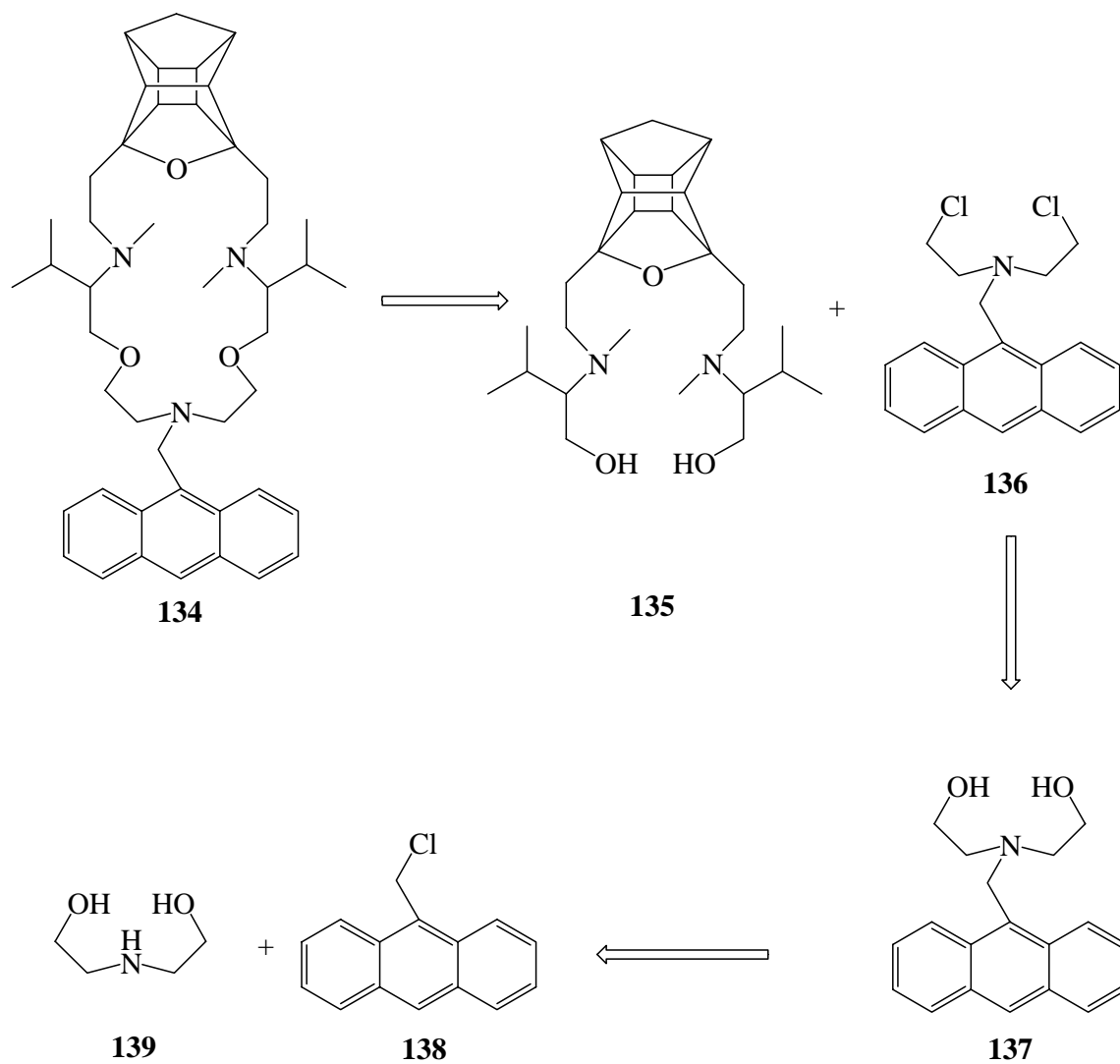

Scheme 37: Retrosynthetic approach to chiral PET sensor **134**

The synthesis of the chiral PCU amino diols is discussed in Chapter 3. The synthesis of the anthracene derived sensor ligand was approached from a number of different directions.

The initial approach involved the use of 9-methylanthracene **140** as the starting material. The methyl group was brominated by reacting the 9-methylanthracene **140** with N-bromosuccinimide (NBS) in carbon tetrachloride (CCl_4) in the presence of a catalytic amount of benzoyl peroxide.¹³

The reaction is presented in scheme 38.

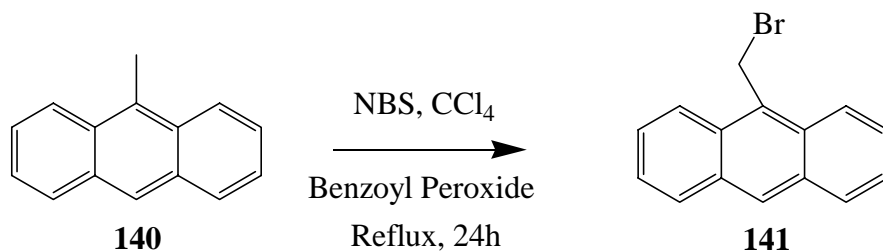

Scheme 38: Synthesis of 9-bromomethyl-anthracene **141**

The reaction was monitored with thin layer chromatography (TLC). When TLC indicated that no starting material remained the reaction was worked up. The resulting mixture of product and by-products proved to be very difficult to purify. Numerous attempts using column chromatography to isolate the product resulted in only a marginal improvement in the purity of the product. NMR analysis of the crude material did however confirm the presence of the product. This crude material was reacted with diethanolamine **139** in toluene in the presence of anhydrous sodium carbonate to yield 9{bis[(hydroxyethyl)amino]methyl}anthracene **137** as shown in the scheme below.¹⁴

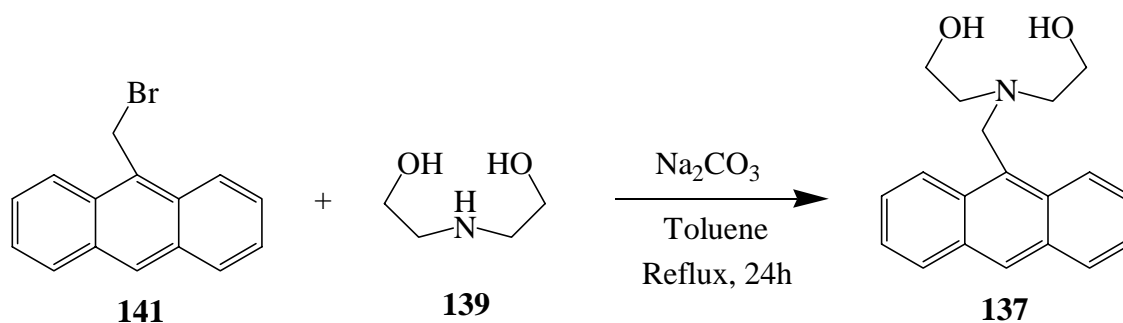

Scheme 39: Synthesis of anthracene diol **137**

The reaction was worked up and the reaction mixture was recrystallised from EtOAc/ Hexane (1:1). It was noted that a significant amount of the crude product would not dissolve in this solvent. This insoluble material was removed by filtration and the soluble material was allowed to crystallize. The resultant yellow microcrystalline solid was found to be the desired product. This was confirmed by NMR analysis. ¹H NMR showed aromatic protons in the region between 7.4 ppm and 8.4 ppm. Triplet peaks at 2.8 ppm and 3.6 ppm representing the methylene protons of the bis(hydroxyethyl)amino moiety confirmed the product.

Due to the messy nature of the reactions carried out above it was decided to use 9-chloromethyl-anthracene as the starting material in order to reduce the number of by-products in the reaction

mixture. The reactions carried out were identical to those outlined in the scheme above. It was found that the reaction mixture did indeed contain significantly less by-products and the resultant yield of the anthracene diol ligand **137** was improved by 20%.

The next step in the synthesis was the conversion of the hydroxyl groups of the ligand **137** to a suitably labile leaving group in order to facilitate the final cyclization reaction to form the desired macrocycle.

Due to the fact that the groups that needed to be converted were hydroxyl groups, it was thought that the simplest approach would be to convert these groups to tosyl moieties. This was to be achieved by simply reacting the diol **137** with *p*-toluenesulphonyl chloride. The resultant tosyl moieties would be ideal leaving groups due to their high lability. The reaction carried out can be seen in the scheme below.

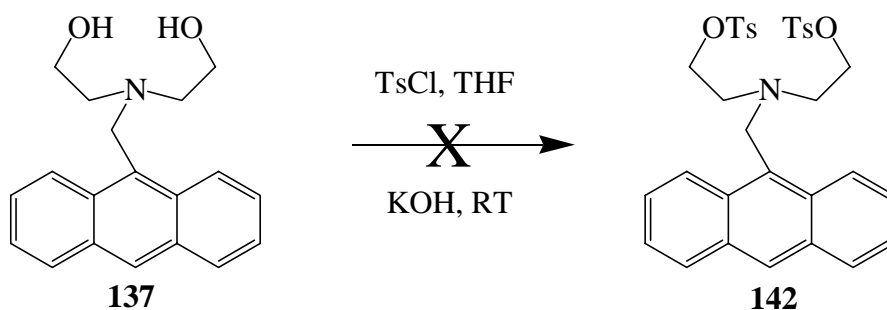

Scheme 40: Attempted synthesis of anthracene ditsoylate **142**

The above reaction was monitored with TLC. It was discovered after 24 hours that the reaction was not proceeding and only starting materials were present in the reaction mixture. The reaction mixture was allowed to stir for a further 24 hours but no reaction occurred. Upon workup only the starting diol compound was recovered.

As a result of the negative result it was decided to explore a different leaving group. It was decided to convert the hydroxyl groups into chloride groups by reacting the diol **137** with thionyl chloride. A search of the literature showed that this had been done successfully by Kaur et al.¹⁵ The diol **137** was reacted with freshly distilled thionyl chloride diluted with dichloromethane to make a 25% solution.¹⁶ The reaction carried out is presented in scheme 41.

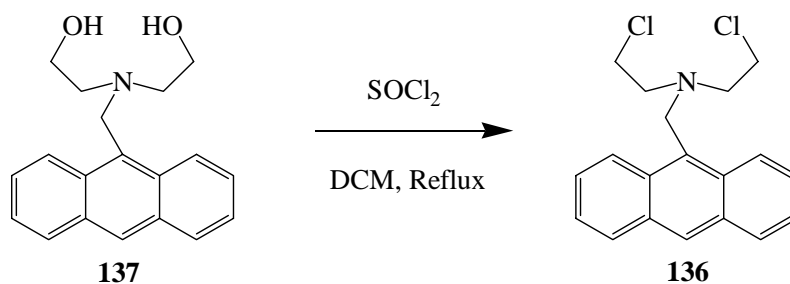

Scheme 41: Synthesis of anthracene dichloro compound **136**

The reaction was monitored using TLC. The reaction was worked up when TLC indicated no further starting material. The crude material was purified using column chromatography with ethyl acetate/ hexane (10:90) as eluents. The resultant yellow microcrystalline solid product **136** was confirmed by NMR and IR. IR shows the broad hydroxyl peak at $\sim 3500\text{ cm}^{-1}$ is no longer present and ^1H NMR shows a shift in the methylene peak from 3.6 ppm to 3.4 ppm. The product also tests positive using the Beilstein copper wire test.

The successful conversion of the hydroxyl group to a suitable leaving group cleared the way for the final cyclization step to be attempted. This was carried out in THF using the high dilution technique and NaH as the base. The proposed reaction scheme can be seen below.

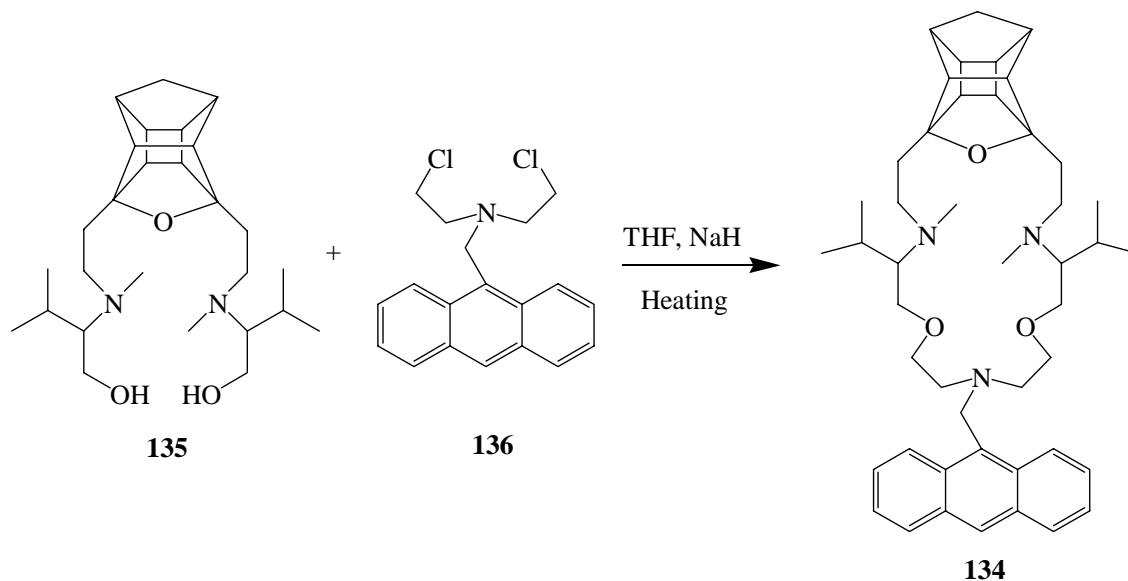

Scheme 42: Cyclization reaction to form PET sensor (**134**)

The above reaction was initially carried out at room temperature for 24 hours. TLC revealed the presence of starting diol material and another compound that was assumed to be product as well

as several by-products. The reaction was heated to ~ 50°C without reaching reflux temperature for a further 24 hours. TLC revealed the presence of only trace amounts of starting diol material. The reaction was worked up and purification using column chromatography was attempted. The presence of several by-products as well as trace amounts of starting material in the same region on TLC as the suspected product made isolation of the product impossible due to the fact that these other compounds co-eluted with the suspected product. It was decided to investigate the use of preparative thin layer chromatography in the purification of the suspected product. This was carried out with little success. The R_f values of the compounds were such that contamination by the by-products was still significant enough to make confirmation of the product by NMR impossible.

CONCLUSION

In conclusion it cannot be said that the attempted synthesis of the chiral PET sensor was unsuccessful. However, all attempts to isolate the suspected product were not successful due to the number of by-products which contaminated all fractions obtained in the various purification attempts. Preparative HPLC may have afforded a solution to this problem but this was unfortunately not a resource that was available. A positive aspect however is that further practice in purification techniques such as preparative TLC was obtained.

REFERENCES

-
- 1 Atkins, P.W. *Physical Chemistry*, 6th Ed, **2000**, Oxford University Press.
 - 2 de Silva, A.P.; Gunaratne, H.Q.N.; Gunnlaugsson, T.; Huxley, A.J.M.; McCoy, C.P.; Rademacher, J.T.; Rice, T.E. *Chem. Rev.* **1997**, 1515-1566.
 - 3 de Silva, A.P.; Rupasinghe, R.A.D.D. *J. Chem. Soc., Chem. Commun.* **1985**, 23, 1669-1670.
 - 4 Bissell, R.A.; de Silva, A.P.; Gunaratne, H.Q.N.; Lynch, P.L.M.; Maguire, G.E.M.; Sandanayake, K.R.A.S. *Chem. Soc. Rev.* **1992**, 187.
 - 5 Callan, J.F.; de Silva, A.P.; Magri, D.C. *Tetrahedron*, **2005**, 61, 8551-8588.
 - 6 Zang, L.; Liu, R.; Holman, M.W.; Nguyen, K.T.; Adams, D.M. *J. Am. Chem. Soc.* **2002**, 124, 10640.
 - 7 Fahrni, C.J.; Yang, L.; VanDerveer, D.G. *J. Am. Chem. Soc.* **2003**, 125, 3799.
 - 8 Tian, H.; Gan, J.; Chen, K.; Song, Q.L.; Hou, X.Y. *J. Mater. Chem.* **2002**, 12, 1262.
 - 9 Geue, J.P.; Head, N.J.; Ward, D.L.; Lincoln, S.F. *Dalton Trans.* **2003**, 521.
 - 10 Kenmoku, S.; Urano, Y.; Kanda, K.; Kojima, H.; Kikuchi, K.; Nagano, T. *Tetrahedron* **2004**, 60, 11067.
 - 11 de Silva, A.P.; Gunaratne, H.Q.N.; Mc Veigh, C.; Maguire, G.E.M.; Maxwell, P.R.S.; O'Hanlon, E. *J. Chem. Soc., Chem. Commun.* **1996**, 2191-2192.
 - 12 Boyle, G.A.; Govender, T.; Kruger, H.G.; Maguire, G.E.M. *Tetrahedron: Asymmetry* **2004**, 15, 3775.
 - 13 Private communication with Dr H.G. Kruger and Dr G.E.M. Maguire, supervisor and co-supervisor.
 - 14 Bissell, R.A.; Calle, E.; de Silva, A.P.; de Silva, S.A.; Gunaratne, H.Q.N.; Habib-Jiwan, J.; Peiris, S.L.A.; Rupasinghe, R.A.D.D.; Samarasinghe, T.K.S.D.; Sandanayake, K.R.A.S.; Soumillion, J. *J. Chem. Soc. Perkin Trans. 2* **1992**, 1559.
 - 15 Kaur, S.; Kumar, S. *Chem. Commun.* **2002**, 2840.
 - 16 Chartres, J.D.; Groth, A.M.; Lindoy, L.F.; Lowe, M.P.; Meehan, G.V. *J. Chem. Soc. Perkin Trans. 1* **2000**, 20, 3444-3450.

CHAPTER 5

CONCLUSION

It seems that in PCU crown ether systems three factors appear important with respect to the efficacy of a chiral host as a catalyst. These are the position of the chiral influence with respect to the cage, the steric bulk of the catalyst and the number of donor atoms in the ring. Ideally, a systematic study of these factors and their variations within the structure of the PCU crown ether catalyst should be performed. The new sugar based macrocycles discussed in chapter 2 would have seen such an alteration in two of these parameters, namely the steric bulk and the position of the chiral influence, as compared to previous PCU catalysts. All attempts to synthesise these new PCU macrocycles, however, proved unsuccessful, even though much time was invested in these efforts and most reasonable approaches to the syntheses were tried. In light of the failure to obtain the sugar based macrocycles, it was decided to revisit the previously reported successful systems and introduce a slight variation, in this case the number of donor atoms. The new macrocycles (**130-131**) are one atom larger (20-azacrown-6) than the previously reported PCU systems (19-azacrown-5). The catalysts were successfully synthesized with reasonable yields and were fully characterized. The macrocycles were tested as chiral phase transfer catalysts in the Michael addition of 2-nitropropane to chalcone. The chemical yields achieved were comparable to previous studies but the selectivity was poor (5 % *ee* versus >90 % *ee* for the previous systems). From this result it can be clearly seen that even a seemingly minor variation in the above mentioned parameters can result in a significant effect in the efficacy of the catalyst.

From the work carried out on the chiral PCU crown ether catalyst systems, certain results can be noted. First, for the Michael addition reaction investigated, i.e. 2-nitropropane to chalcone, five donor macrocycles are the most successful catalysts. This is shown in the previous study, where five donor PCU catalysts gave good selectivity, and reinforced by the fact that the six donor systems used in this investigation proved to be poor in terms of selectivity. Second, it is apparent that the structure of the host, and not the base used, is responsible for the variation of the results obtained. Third, all attempts to derivatise the hydroxyl groups of the amino diol ligands to form leaving groups were unsuccessful. This cyclization methodology, i.e. where the leaving groups are on the cage ligand, can therefore be ruled out as a synthetic approach in future investigations. The complexity surrounding the synthesis of these macrocyclic systems begs the question of

whether alternative systems, such as acyclic cage derived ligands, should not be investigated as chiral catalysts in these applications.

CHAPTER 6

EXPERIMENTAL

Melting points are uncorrected. Optical rotations were measured on a Perkin Elmer 341 polarimeter. Infrared spectra were recorded on a Nicolet Impact 410 spectrometer. All mass spectrometric analyses were carried out on a VG70-70E mass spectrometer. FAB mass spectra were obtained by bombardment of samples with xenon atoms (1 mA at 8 keV). *m*-Nitrobenzyl alcohol was used as matrix. NMR spectra were recorded on a Varian Gemini-300 MHz spectrometer. Tetrahydrofuran and toluene were freshly distilled prior to use from sodium benzophenone ketyl under nitrogen atmosphere. All novel compounds synthesized in this study are denoted by an asterisk (*).

EXPERIMENTAL FOR CHAPTER 2

Pentacyclo[5.4.0.0^{2,6}.0^{3,10}.0^{5,9}]undecane-8,11-dione (66)¹

The synthesis was adapted from literature. *p*-Benzoquinone (240.0 g, 2.22 mol) in toluene (1 L) was cooled to 0 °C via application of an external ice bath. To this was added, over 8 hours, with stirring a solution of freshly cracked cyclopentadiene (171.6 g, 2.6 mol). The reaction mixture was allowed to warm gradually to room temperature with stirring. The product was filtered and recrystallised from dichloromethane to yield the adduct as yellowish-green crystals **65** (280.0 g, 68%).

The above adduct (**65**, 60.0 g) was dissolved in hexane/acetone (90:10) and exposed to direct sunlight until a clear solution was obtained. The solvent was evaporated to give the product as a colourless microcrystalline solid **66** (52.0 g, 86%), m.p. 233 °C. NMR [CDCl₃, 300 MHz]: δ_H 1.89 (s, 1H) 1.86 (AB, *J*_{AB} = 10.8 Hz, 1 H), 2.06 (AB, *J*_{AB} = 10.8 Hz, 1 H), 2.76 (s, 2 H), 2.80 (s, 2 H), 2.92 (s, 2 H), 3.18 (s, 2 H); ¹³C NMR [CDCl₃, 50 MHz]: δ_C 38.7 (t), 40.5 (d), 43.8 (d), 44.6 (d), 54.7 (d), 212.1 (s).

***exo*-8-*exo*-11-Diallylpentacyclo[5.4.0.0^{2,6}.0^{3,10}.0^{5,9}]undecane-*endo*-8-*endo*-11-diol (84)²**

A solution of dione **66** (20.0 g, 0.115 mol) in dry THF (200 mL) was added dropwise over 2 hours to a stirred suspension of freshly prepared allylmagnesium bromide under nitrogen at 0 °C. After the addition had been completed, the external ice-water bath was removed, and the reaction

mixture was allowed to warm gradually to ambient temperature while stirring under nitrogen during 24 hours. The reaction was quenched via addition of saturated aqueous NH_4Cl (until pH is 6~7), the layers were separated, and the aqueous layer was extracted with EtOAc (2 x 500 mL). The combined organic extracts were dried (Na_2SO_4) and filtered, and the filtrate was concentrated *in vacuo*. The residue was recrystallised from hexane, thereby affording pure **84** (26.99g, 91%) as a colourless microcrystalline solid: m.p. 82-83 °C; IR (KBr): ν_{max} 3169, 2976, 1639 cm^{-1} ; ^1H NMR [CDCl_3 , 200 MHz]: δ_{H} 1.05 (AB, $J_{\text{AB}} = 10.8$ Hz, 1 H), 1.49 (AB, $J_{\text{AB}} = 10.8$ Hz, 1 H), 1.97-2.24 (m, 6 H), 2.30-2.61 (m, 6 H), 5.01 (dd, $J = 8.0$ & 2.6 Hz, 2 H), 5.04 (dd, $J = 16.85$ & 2.6 Hz, 2 H), 5.90 (m, 2 H), 6.52 (br s, 2 H); ^{13}C NMR [CDCl_3 , 50 MHz]: δ_{C} 33.9 (t), 40.0 (d), 42.8 (d), 44.0 (d), 44.1 (t), 49.1 (d), 77.2 (s), 117.5 (t), 133.8 (d). CI MS: Calc. for $\text{C}_{17}\text{H}_{22}\text{O}_2$: $[\text{M} + \text{H}]^+$ m/z 259.16981. Found: $[\text{M} + \text{H}]^+$ m/z 259.16994:

3,5-Diallyl-4-oxahexacyclo[5.4.1.0^{2,6}.0^{3,10}.0^{5,9}.0^{8,11}]dodecane (85)³

A solution of **84** (15.0 g, 58.0 mmol) and *p*-toluenesulphonic acid (1.50 g, 0.79 mmol, catalytic amount) in benzene (500 ml) was refluxed in a Dean-Stark apparatus and the resulting water was removed azeotropically. After every 12 hours, additional *p*-toluenesulphonic acid (500 mg) was added. When TLC indicated the absence of **84** (72 hours), the reaction mixture was allowed to cool gradually to ambient temperature and washed sequentially with 10% aqueous NaHCO_3 (100 mL), water (100 mL) and brine (100 mL). The organic layer was dried (MgSO_4) and filtered, and the filtrate was concentrated *in vacuo*. The residue was purified via column chromatography on silica gel by eluting with EtOAc-hexane (5:95). Pure **85** (11.4 g, 82%) was thereby obtained as a colourless oil; IR (neat): ν_{max} 3075, 2965, 1640, 997, 910 cm^{-1} ; ^1H NMR (CDCl_3): δ_{H} 1.46 (AB, $J_{\text{AB}} = 10.2$ Hz, 1 H), 1.82 (AB, $J_{\text{AB}} = 10.2$ Hz, 1 H), 2.35 (br s, 2 H), 2.45-2.65 (m, 10 H), 5.01 (dd, $J = 9.8$ & 2.2 Hz, 2 H), 5.07 (dd, $J = 15.4$ & 1.4 Hz, 2 H), 5.78 (m, 2 H); ^{13}C NMR (CDCl_3): δ_{C} 37.5 (t), 41.7 (d), 43.3 (t), 44.5 (d), 47.8 (d), 58.6 (d), 95.1 (s), 116.8 (t), 134.4 (d). CI MS: Calc. for $\text{C}_{17}\text{H}_{20}\text{O}$: $[\text{M} + \text{H}]^+$ m/z 241.1592. Found: $[\text{M} + \text{H}]^+$ m/z 241.1601:

3,5-(2',2''-bis(hydroxyethyl))-4-oxahexacyclo(5.4.1.0^{2,6}.0^{3,10}.0^{5,9}.0^{8,11})dodecane (86)

A solution of the diene (**85**, 5.0 g, 20.3 mmol) in dry methanol (150 mL) was cooled to -78 °C via application of an external dry ice-acetone bath and purged with nitrogen during 20 minutes. Ozone was bubbled into the mixture until a blue-purple colour persisted, thereby indicating the presence of excess ozone and completion of reaction. Excess ozone was flushed from the reaction mixture with a stream of nitrogen, and the reaction mixture was transferred to a 2 l flask.

Sodium borohydride (3.0 g, 81 mmol) was added over 1 hour to a stirred, ice bath cooled mixture of the ozonide. The resulting mixture was stirred at ambient temperature for 12 hours and concentrated *in vacuo*. Excess sodium borohydride was quenched with 10 % HCl (200 ml) and extracted with ethyl acetate to give pure product (**86**, 4.40 g, 89%) as a colourless microcrystalline solid: mp 153-153.5 °C; IR (KBr): ν_{\max} 3320(m), 2980(s) cm^{-1} ; ^1H NMR [CDCl_3 , 300 MHz]: δ_{H} 1.52 (d, $J=10.3$ Hz, 1H), 1.70-2.05 (m, 4H), 2.28-2.69 (m, 9H), 3.50-3.86 (m, 6H); ^{13}C NMR [CDCl_3 , 50 MHz]: δ_{C} 34.3 (t), 41.4 (d), 43.5 (t), 44.1 (d), 47.7 (d), 58.2 (d), 60.0 (t), and 92.4 (s).

Synthesis of PCU ditosylate (**87**)

To a solution of **86** (5.0 g, 20.1 mmol) and *p*-toluenesulphonyl chloride (11.49 g, 60.3 mmol) in THF (200 ml) was added finely powdered KOH (17.0 g, 0.3 mol). This mixture was stirred under nitrogen and monitored via TLC (hexane/ethyl acetate; 50:50). When no more diol ($r_f = 0.5$) nor monotosylated product ($R_f = 0.2$) were detected by TLC, water (100 ml) was added to the reaction vessel and the layers are separated. The aqueous phase was extracted with ethyl acetate and the combined organic layers were dried over anhydrous MgSO_4 . The product was concentrated *in vacuo* and purified via column chromatography (ethyl acetate/hexane; 20:80) to give the product (**86**) as a colourless microcrystalline solid: ; ^1H NMR [CDCl_3 , 300 MHz]: δ_{H} 1.43 (AB, $J_{\text{AB}}=10.5$ Hz, 1H), 1.77 (AB, $J_{\text{AB}}=10.5$ Hz, 1H), 2.03 (t, $J = 7.0$ Hz, 4H), 2.29-2.50 (m, 8H), 2.69 (s, 6H), 4.04 (t, $J = 7.0$ Hz, 4H), 7.29 (AB, $J_{\text{AB}}=8.1$ Hz, 4H), 7.72 (AB, $J_{\text{AB}}=8.4$ Hz, 4H).

2,2-Dimethyl-[1,3]dioxolane-4,5-dicarboxylic acid dimethyl ester (**93**)⁴

A mixture of dimethyl L-tartrate (35.6 g, 0.20 mol), 2,2-dimethoxypropane (31.4 g, 0.30 mol) and *p*-toluenesulfonic acid monohydrate (0.121 g, 0.64 mmol) in benzene (800 ml) was heated under reflux under a Soxhlet extractor containing fresh 4A molecular sieves for 3 hours. Anhydrous K_2CO_3 (0.2 g) was added and the solution stirred at room temperature for 4 h. The solution was filtered and the solvent removed under reduced pressure. The residue was taken up into diethyl ether and washed with saturated aqueous sodium bicarbonate (50 ml) and saturated NaCl (50 ml). The solvent was evaporated and the residue was vacuum distilled (0.2 mmHg) at 113 °C to yield 38.5g (88%) of the product. ^1H NMR [CDCl_3 , 300 MHz]: δ_{H} 1.43 (s, 3H), 3.76 (s, 3H), 4.75 (s, 1H); ^{13}C NMR [CDCl_3 , 50 MHz]: δ_{C} 26.3 (q), 52.8 (q), 76.9 (d), 113.9 (s), 170.1 (s).

(5-Hydroxymethyl-2,2-dimethyl-[1,3]dioxolan-4-yl) methanol (94)

Ester (7.2 g, 33.0 mmol) was added to a stirred suspension of lithium aluminium hydride (5.0 g, 0.13 mol) in dry THF under nitrogen. The solution was stirred at ambient temperature during 24 h. The solution was diluted with diethyl ether and the excess LAH was quenched via the dropwise addition of saturated aqueous Na₂SO₄. The solution was filtered and the solvent removed under reduced pressure to yield the product (**94**) (4.81 g, 90%) as a colourless oil. ¹H NMR [CDCl₃, 300 MHz]: δ_H 1.43 (s, 3H), 2.68 (s, 1H), 3.70 (q, 2H), 3.96 (s, 1H); ¹³C NMR [CDCl₃, 50 MHz]: δ_C 27.0 (q), 62.1 (t), 78.2 (d), 109.3 (s).

2-[5-(Hydroxy-1-methyl-ethyl)-2,2-dimethyl-[1,3] dioxolan-4-yl]-propan-2-ol (95)⁵

Ester (10.9 g, 50.0 mmol) in dry THF (100 ml) was added dropwise to a solution of methylmagnesium bromide (500 ml) in dry THF under nitrogen at 0°C. The solution was stirred at ambient temperature overnight under nitrogen. The reaction was quenched via the addition of saturated aqueous NH₄Cl. The layers were separated and the aqueous layer was extracted with EtOAc (2x 100 ml). The combined organic layers were dried (Na₂SO₄) and the solvent removed *in vacuo* to yield the product as a microcrystalline solid (8.0 g, 74%). ¹H NMR [CDCl₃, 300 MHz]: δ_H 1.24 (s, 3H), 1.28 (s, 3H), 1.36 (s, 3H), 3.04 (s, 1H), 3.74 (s, 1H); ¹³C NMR [CDCl₃, 50 MHz]: δ_C 23.8 (q), 27.2 (q), 29.1 (q), 71.0 (s), 82.8 (d), 107.6 (s).

[5-(Hydroxy-diphenyl-methyl)-2,2-dimethyl-[1,3] dioxolan-4-yl]diphenyl methanol (96)

To a freshly prepared suspension of phenylmagnesium bromide in dry THF at 0 °C under nitrogen was added dropwise a solution of ester (10.0 g, 46.0 mmol, 100 ml). The solution was allowed to warm slowly to ambient temperature. The solution was stirred at ambient temperature overnight under nitrogen. The reaction was quenched via the addition of saturated aqueous NH₄Cl. The layers were separated and the aqueous layer was extracted with EtOAc (2x 100 ml). The combined organic layers were dried (Na₂SO₄) and the solvent removed *in vacuo* to yield the product as a microcrystalline solid (14.9 g, 70%). ¹H NMR [CDCl₃, 300 MHz]: δ_H 1.02 (s, 3H), 4.28 (s, 1H), 4.58 (s, 1H), 7.20-7.64(m, 10H); ¹³C NMR [CDCl₃, 50 MHz]: δ_C 27.2 (q), 78.2 (s), 80.9 (d), 109.6 (s), 127.3 (d), 127.6 (d), 127.7 (d), 128.2 (d), 128.7 (d), 142.6 (s), 145.9 (s).

Synthesis of PCU amino diol (103)*

A mixture of the 2-(methylamino)-ethanol (2.37 g, 31.5 mmol.), PCU ditosylate (7.93 g, 14.3 mmol.) and K₂CO₃ in CH₃CN was refluxed for 4 days under nitrogen. The reaction mixture was

cooled, filtered and concentrated *in vacuo*. The residue was purified via column chromatography on silica gel using chloroform:methanol:NH₄OH (88:10:2) as eluents to give the product as a clear oil (4.2 g, 82%). IR (KBr): ν_{\max} 3383(br, s), 2952(vs), 2860(m), 1467(m), 1049(m) cm⁻¹; FAB⁺ MS (*m*-Nitrobenzyl alcohol): m/z 363 [M+H]⁺; ¹H NMR [CDCl₃, 300 MHz]: δ_{H} 1.49 (AB, $J_{\text{AB}} = 10.5\text{Hz}$, 1H), 1.85 (AB, $J_{\text{AB}} = 10.5\text{Hz}$, 1H), 1.89-2.05 (m, 4H), 2.15 (s, 6H), 2.25-2.70 (m, 12H), 3.45-3.55 (m, 2H), ¹³C NMR [CDCl₃, 75 MHz]: δ_{C} 30.06 (t), 30.94 (q), 41.64 (d), 43.45 (t), 44.31 (d), 47.90 (d), 53.79(t), 58.45(t), 58.65 (t), 58.68 (d), 94.99 (s).

Attempted synthesis of cage amino ditosylate (102)

To a solution of **103** (4.2 g, 11.7 mmol) and *p*-toluenesulphonyl chloride (6.7 g, 35.1 mmol) in THF (200 ml) was added finely powdered KOH (6.6 g, 0.117 mol). This mixture was stirred under nitrogen and the reaction was monitored via TLC (chloroform). When no reaction was noted the mixture was filtered and the organic layer was dried and concentrated.

Attempted synthesis of cage amino dichloro compound (106)⁶

To a solution of **103** (0.5 g, 14 mmol) in dichloromethane (40 ml) was added SOCl₂ (20 ml). The solution was stirred at room temperature overnight. The reaction was monitored using TLC (chloroform). When no reaction was observed, the reaction mixture was refluxed for a further 12h. The solvent was removed under reduced pressure.

Attempted synthesis of cage dibromo compound (107)

To a stirred solution of aqueous HBr (48%) was added **103** (0.5 g, 1.4 mmol). The solution was stirred at room temperature and at reflux. When no reaction was noted the solvent was removed under reduced pressure and the residue neutralized with aqueous Na₂CO₃. The solution was extracted with EtOAc. The organic layer was dried and concentrated.

(2-Bromo-ethyl)-methyl-amine hydrobromide (108)^{7,8}

To a cooled, stirred solution of 48%w/w HBr (100 ml) was added dropwise 2-(methylamino)-ethanol **104** (10.0 g, 0.13 mol). The solution was refluxed for 2 h. The apparatus was configured for distillation and the water produced during reaction was distilled off. The apparatus was reconfigured for reflux and the procedure was repeated. The overall procedure was repeated until no more water was produced. The crude brown residue was recrystallized from cold acetone.

The product **108** was recovered as colourless crystals (23.2 g, 80%). ^1H NMR [CDCl_3 , 300 MHz]: δ_{H} 2.82 (s, 3H), 3.47 (t, 2H), 3.83 (t, 2H), 9.23 (t, 2H).

Attempted synthesis of chiral diamine (**109**)

To a stirred solution of **94** (1.0 g, 6.2 mmol) and NaH (0.5 g) in dry THF was added dropwise a solution of **108** (3.4 g, 2.5 eq) in dry THF at room temperature under a nitrogen atmosphere. The solution was stirred overnight. The reaction was quenched by dropwise addition of water. The organic layer was dried and concentrated.

Toluene-4-sulphonic acid 2-chloro-ethyl-ester (**117**)

To a solution of 2-chloroethanol **116** (5.0 g, 62 mmol) and *p*-toluenesulphonyl chloride (14.2 g, 1.2 eq) in THF (200 ml) was added finely powdered KOH (17.4 g, 5 eq). This mixture was stirred under nitrogen and monitored via TLC (hexane/ethyl acetate; 50:50). When no more starting material was detected by TLC, water (100 ml) was added to the reaction vessel and the layers were separated. The aqueous phase was extracted with ethyl acetate and the combined organic layers were dried over anhydrous Na_2SO_4 . The product was concentrated in *vacuo* and purified via column chromatography (ethyl acetate/hexane; 20:80) to give the product (**117**) as a colourless oil. ^1H NMR [CDCl_3 , 300 MHz]: δ_{H} 2.45 (s, 3H), 3.65 (t, 2H), 4.24 (t, 2H), 7.36 (d, 2H), 7.82 (d, 2H). ^{13}C NMR [CDCl_3 , 75 MHz]: δ_{C} 21.65 (q), 40.8 (t), 68.9 (t), 127.9 (s), 129.9(s), 132.4 (s), 145.2(s).

Attempted synthesis of chiral dichloro compound (**118**) using Toluene-4-sulphonic acid 2-chloro-ethyl-ester (**117**)⁹

A number of different procedures are presented below:

To a stirred solution of **96** (1.0 g, 2.2 mmol) and NaH (0.5 g) in dry THF was added dropwise a solution of **117** (1.1 g, 2.2 eq) in dry THF at room temperature under a nitrogen atmosphere. The solution was stirred overnight. When no reaction was noted the solution was heated at reflux for a further 24 h. The reaction was quenched by dropwise addition of water. The organic layer was dried and concentrated.

To a stirred solution of **96** (1.0 g, 2.2 mmol) and K_2CO_3 (0.8 g) in dry acetonitrile was added dropwise a solution of **117** (1.1 g, 2.2 eq) in dry acetonitrile at room temperature under a nitrogen atmosphere. The solution was stirred overnight. When no reaction was noted the solution was

heated at reflux for a further 24 h. The reaction was filtered. The organic layer was dried and concentrated.

To a stirred solution of **96** (1.0 g, 2.2 mmol) and Cs_2CO_3 (3.1 g) in dry DMF was added dropwise a solution of **117** (1.1 g, 2.2 eq) in dry DMF at room temperature under a nitrogen atmosphere. The solution was stirred overnight. When no reaction was noted the solution was heated at reflux for a further 24 h. The reaction was filtered and the solvent removed under reduced pressure. The residue was washed with brine and extracted with EtOAc. The organic layer was dried and concentrated.

To a stirred solution of **96** (1.0 g, 2.2 mmol) and KOH (0.8 g) in ethanol was added dropwise a solution of **117** (1.1 g, 2.2 eq) in ethanol at room temperature under a nitrogen atmosphere. The solution was heated at reflux for 24 h. The reaction was filtered. The organic layer was concentrated under reduced pressure.

A solution of **96** (1.0 g, 2.2 mmol) and Cs_2CO_3 (3.1 g) and **117** (1.1 g, 2.2 eq) in dry DMF was placed in a sealed pressure tube. The solution was heated at 100°C for 48h. The reaction was filtered and the solvent removed under reduced pressure. The residue was washed with brine and extracted with EtOAc. The organic layer was dried and concentrated.

Attempted synthesis of chiral dichloro compound (118) using 1-bromo-2-chloroethane (119)

A number of different procedures are presented below:

To a stirred solution of **96** (1.0 g, 2.2 mmol) and NaH (0.5 g) in dry THF was added dropwise a solution of **119** (0.34 g, 0.19 ml, 2.2 eq) in dry THF at room temperature under a nitrogen atmosphere. The solution was stirred overnight. When no reaction was noted the solution was heated at reflux for a further 24 h. The reaction was quenched by dropwise addition of water. The organic layer was dried and concentrated.

To a stirred solution of **96** (1.0 g, 2.2 mmol) and K_2CO_3 (0.8 g) in dry acetonitrile was added dropwise a solution of **119** (0.34 g, 0.19 ml, 2.2 eq) in dry acetonitrile at room temperature under a nitrogen atmosphere. The solution was stirred overnight. When no reaction was noted the solution was heated at reflux for a further 24 h. The reaction was filtered. The organic layer was dried and concentrated.

To a stirred solution of **96** (1.0 g, 2.2 mmol) and Cs₂CO₃ (3.1 g) in dry DMF was added dropwise a solution of **119** (0.34 g, 0.19 ml, 2.2 eq) in dry DMF at room temperature under a nitrogen atmosphere. The solution was stirred overnight. When no reaction was noted the solution was heated at reflux for a further 24 h. The reaction was filtered and the solvent removed under reduced pressure. The residue was washed with brine and extracted with EtOAc. The organic layer was dried and concentrated.

A solution of **96** (1.0 g, 2.2 mmol) and Cs₂CO₃ (3.1 g) and **119** (0.34 g, 0.19 ml, 2.2 eq) in dry DMF was placed in a sealed pressure tube. The solution was heated at 100 °C for 48 h. The reaction was filtered and the solvent removed under reduced pressure. The residue was washed with brine and extracted with EtOAc. The organic layer was dried and concentrated.

EXPERIMENTAL FOR CHAPTER 3

Preparation of *N*-formyl amino acids

Acetic anhydride (30 eq) was added dropwise to a stirred solution of the amino acid (1 eq) in formic acid (approximately 30 ml per 1.0 g of amino acid) at 0 °C. After addition of the acetic anhydride, the external ice bath was removed and the solution stirred at room temperature during 24 hours. The solution was treated with water (60 ml) and stirred for 1 hr. The solvent was removed under reduced pressure to yield a white residue. This residue was recrystallised from water to yield the pure product.

(*S*)-(+)-*N*-formyl leucine (**123**)¹⁰ : yield 85 %, ¹H NMR (DMSO-*d*₆) δ_H 0.97 (d, *J* = 6.2Hz, 6H), 1.70-1.92 (m, 3H), 4.10 (m, 1H), 5.95 (d, *J* = 8Hz, 1H, NH), 8.23 (s, 1H, CHO)

(*S*)-(+)-*N*-formyl phenylglycine (**124**)¹¹ : yield 80 %, ¹H NMR (DMSO-*d*₆) δ_H 5.37 (d, 1H, *J* = 8Hz), 7.27-7.43 (m, 5H), 8.07 (s, 1H), 9.01 (d, 1H, *J* = 9 Hz)

Preparation of *N*-methyl amino alcohols

N-formyl-amino acid (1 eq) was added to a stirred solution of lithium aluminium hydride (4 eq) in dry THF at 0 °C. The external icebath was removed and the solution was allowed to warm gradually overnight and stirred for a further 12 hours at ambient temperature. The reaction mixture was once again cooled to 0 °C and an equal volume of diethyl ether was added. The reaction was quenched with saturated aqueous Na₂SO₄. The solution was filtered and the solvent removed in *vacuo*.

S-(+)-N-methyl leucinol (125)¹² : yield 96 %, ¹H NMR (CDCl₃) δ_H 0.9 (d, *J* = 7 Hz, 6H), 1.25 (t, *J* = 7 Hz, 2H), 1.5-1.9 (m, 1H), 2.4 (s, 3H), 3.3-3.7 (m, 3H), 3.8 (s, 2H)

(S)-(+)-N-methyl phenylglycinol (126): yield 90 %, ¹H NMR (CDCl₃) δ_H 2.32 (s, 2H), 2.68 (br s, 2H), 3.51-3.78 (m, 3H), 7.21-7.42 (m, 5H)

Preparation of PCU amino diol ligands

A mixture of the amino alcohol (2.2 eq.), PCU ditosylate (1 eq.) and Na₂CO₃ in CH₃CN was refluxed for 4 days under nitrogen. The reaction mixture was cooled, filtered and concentrated *in vacuo*. The residue was purified via column chromatography on silica gel.

PCU leucine diol (127) was prepared as described above. The crude product was purified by chromatography on silica gel using CHCl₃/MeOH/NH₄OH; 93:5:2 as eluents to give the product as a clear oil (62%). [α]_D²⁰ +23.22(c = 5, CHCl₃); IR (KBr): ν_{max} 3411(br, s), 2954(vs), 1464(m), 1057(m), 1032(m) cm⁻¹; FAB⁺ MS (*m*-Nitrobenzyl alcohol): *m/z* 475 [M+H]⁺; ¹H NMR [CDCl₃, 300 MHz]: δ_H 0.85 (t, 12H), 0.91-1.05 (m, 2H), 1.19-1.32 (m, 2H), 1.48-1.52 (m, 3H), 1.79-1.98 (m, 5H), 2.15 (s, 6H), 2.25-2.80 (m, 16H), 3.10-3.21 (m, 2H), 3.35-3.45 (m, 2H); ¹³C NMR [CDCl₃, 75 MHz]: δ_C 22.15 (q), 23.74 (q), 25.30 (d), 25.35 (d), 31.31 (t), 33.73 (t), 33.78 (t), 35.64 (q), 35.72 (q), 41.52 (d), 41.58 (d), 43.46 (t), 44.25 (d), 47.88 (d), 49.83 (t), 58.55 (d), 58.59 (d), 61.11 (t), 62.05 (d), 62.09 (d), 95.03 (s), 95.08 (s):

PCU phenylglycine diol (128) was prepared as described above. The crude product was purified by chromatography on silica gel using 93 CHCl₃:5 MeOH:2 NH₄OH as eluents to give the product as a waxy solid (59%). [α]_D²⁰ +28.57(c = 7, CHCl₃); IR (KBr): ν_{max} 3393(br, s), 2961(vs), 1458(m), 1026(m), 706(m) cm⁻¹; FAB⁺ MS (*m*-Nitrobenzyl alcohol): *m/z* 515 [M+H]⁺; ¹H NMR [CDCl₃, 300 MHz]: δ_H 1.49 (AB, *J*_{AB} = 10.5Hz, 1H), 1.85 (AB, *J*_{AB} = 10.5Hz, 1H), 1.89-2.05 (m, 4H), 2.15 (s, 6H), 2.25-2.70 (m, 12H), 3.05 (br s, 2H, deuterium exchangeable), 3.55-3.65 (m, 2H), 3.70-3.82 (m, 2H); 3.86-4.00 (m, 2H), 7.10-7.40 (m, 10H); [CDCl₃, 75 MHz]: δ_C 30.28 (t), 36.95 (q), 37.17 (q), 41.53 (d), 41.59 (t), 43.48 (t), 44.25 (d), 44.30 (d), 47.90 (d), 47.99 (d), 50.06 (t), 50.21 (t), 58.53 (d), 58.68 (d), 60.75 (t), 68.77 (d), 68.83 (d), 95.16 (s), 95.20 (s), 127.80 (d), 128.20 (d), 128.96 (d), 135.69 (s), 135.79 (s):

Preparation of Macrocycles (130-131)*

To a suspension of NaH (4 eq.) in THF (100 ml/0.5 NaH) at 0 °C was added a solution of the diamino diol (**127-128**, 1 eq.) dropwise under a nitrogen atmosphere. The solution was allowed

to warm ambient temperature. The solution was again cooled to 0 °C and a solution of 2,6-dibromomethyl pyridine (**129**, 1,2 eq) was added dropwise. The reaction mixture was allowed to warm to ambient temperature and stirred for a further 24 hours after dropping had been completed. The solution was filtered and concentrated *in vacuo* to give the crude product as a very viscous oil. This oil was chromatographed on silica gel by eluting with chloroform/methanol/ammonium hydroxide; 96:2:2 to afford the pure macrocycles.

Macrocycle 130*: waxy solid (42%) $[\alpha]_D^{20} +9.75$ (c = 5.6, CHCl₃); IR (KBr): ν_{\max} 2952(vs), 2866(m), 1593(m), 1461(m), 1109(m) cm⁻¹; FAB⁺ MS (*m*-Nitrobenzyl alcohol): *m/z* 578 [M+H]⁺; ¹H NMR [CDCl₃, 300 MHz]: δ_H 0.82 (t, 12H), 1.10-1.35 (m, 4H), 1.37-1.47 (AB, J_{AB} 10 Hz, 1H), 1.53-1.78 (m, 2H); 1.81-2.00 (m, 5H), 2.1-2.55 (m, 20H), 3.32-3.48 (m, 2H), 3.5-3.65 (m, 2H); 4.45-4.65 (m, 4H), 7.25-7.35 (m, 2H), 7.65 (t, 1H); ¹³C NMR [CDCl₃, 75 MHz]: δ_C 22.73 (q), 22.97 (q), 25.13 (d), 30.97 (t), 31.03 (t), 37.79 (q), 37.73 (q), 38.35 (t), 38.43 (t), 41.26 (d), 41.29 (d), 43.44 (t), 43.84 (d), 47.20 (d), 48.20 (d), 49.79 (t), 49.93 (t), 57.95 (d), 58.91 (d), 60.50 (d), 60.09 (d), 70.07 (t), 71.07 (t), 73.81 (t), 73.96 (t), 94.82 (s), 120.93 (d), 120.99 (d), 136.99 (d), 137.12 (d), 157.84 (s)

Macrocycle 131*: waxy solid (40%) $[\alpha]_D^{20} +17.38$ (c = 4, CHCl₃); IR (KBr): ν_{\max} 2925(vs), 2866(m), 1672(m), 1461(m), 1122(m) cm⁻¹; FAB⁺ MS (*m*-Nitrobenzyl alcohol): *m/z* 618 [M+H]⁺; ¹H NMR [CDCl₃, 300 MHz]: δ_H 1.49 (AB, J_{AB} = 10.5Hz, 1H), 1.70-2.73 (m, 25H), 3.42-4.00 (m, 4H); 4.50-4.75 (m, 4H), 7.15-7.42 (m, 14H), 7.65 (t, 1H); ¹³C NMR [CDCl₃, 75 MHz]: δ_C 31.72 (t), 39.75 (q), 39.84 (q), 41.49 (d), 41.53 (d), 43.43 (t), 44.08 (d), 47.77 (d), 47.82 (d), 49.84 (t), 49.98 (t), 58.42 (d), 58.50 (d), 67.66 (d), 71.09 (t), 71.71 (t), 94.81 (s), 120.79 (d), 120.82 (d), 127.18 (d), 127.23 (d), 127.31 (d), 127.57 (d), 128.19 (d), 128.22 (d), 128.25 (d), 128.32 (d), 128.40 (d), 128.43 (d), 128.46 (d), 128.49 (d), 128.52 (d), 128.58 (d), 137.03 (d), 157.84 (s), 157.90 (s):

General procedure for the Michael addition of 2-nitropropane to chalcone

The corresponding macrocycle (0.05 mmol) and potassium *t*-butoxide (0.05 mmol) was added to a solution of chalcone (1.44 mmol) and 2-nitropropane (3.36 mmol) in dry toluene (3 ml). The mixture was stirred under inert atmosphere at ambient temperature. After the desired reaction time, water (5 ml) and toluene (5 ml) was added. The organic phase was separated and dried over Na₂SO₄. The solvent was evaporated and the crude product purified by preparative thin layer chromatography (Hexane/EtOAc; 9:1). The enantiomeric excess (*ee*) was determined by measuring the specific rotation and comparing this to a literature value.

EXPERIMENTAL FOR CHAPTER 4

Preparation of PCU valine diol ligand (135)

A mixture of the amino alcohol (2.2 eq.), PCU ditosylate (1 eq.) and Na₂CO₃ in CH₃CN was refluxed for 4 days under nitrogen. The reaction mixture was cooled, filtered and concentrated *in vacuo*. The residue was purified via column chromatography on silica gel.

PCU valine diol (135) was prepared as described above. The crude product was purified by chromatography on silica gel using CHCl₃/MeOH/NH₄OH; 93:5:2 as eluents to give the product as a clear oil (64%). [α]_D²⁰ -8.98 (c = 2.3, CHCl₃); IR (KBr): ν_{\max} 3343(br, s), 2952(vs), 1454(m), 1056(m) cm⁻¹; FAB⁺ MS (*m*-Nitrobenzyl alcohol): *m/z* 446 [M+H]⁺; ¹H NMR [CDCl₃, 300 MHz]: δ_{H} 0.70 (d, *J* = 6.6Hz, 6H), 0.85 (d, *J* = 6.6Hz, 6H), 1.48 (AB, *J*_{AB} = 10.5Hz, 1H), 1.62-1.93 (m, 5H), 2.1-2.9 (m, 22H), 3.0-3.12 (m, 2H), 3.46-3.50 (m, 2H), 4.1 (br s, 2H, deuterium exchangeable); ¹³C NMR [CDCl₃, 75 MHz]: δ_{C} 19.83 (q), 22.20 (q), 27.87 (q), 31.06 (t), 34.91 (q), 35.07 (q), 41.28 (d), 41.45 (d), 43.39 (t), 44.02 (d), 44.11 (d), 46.83 (d), 48.32 (d), 52.49 (t), 52.63 (t), 57.45 (d), 58.87 (d), 59.31 (t), 71.22 (d), 71.29 (d), 95.08 (s), 95.18 (s):

9-Bromomethyl-anthracene (141)

To a stirred solution of 9-methylanthracene **140** (3.0 g, 15.6 mmol) in CCl₄ (60 ml) was added *N*-bromosuccinamide (NBS) (3.33 g, 18.7 mmol, 1.2 eq) and benzoyl peroxide (0.2 g, catalytic). The mixture was refluxed overnight. The solvent was removed under reduced pressure and the residue was taken up in CH₂Cl₂. The organic layer was extracted first with brine and then with distilled water. The organic layer was dried (Na₂SO₄) and concentrated. The crude product was obtained as a yellow solid (5.04 g). This material was purified using column chromatography with EtOAc/Hexane (50:50) as eluents. The product **141** was obtained as a yellow solid (2.74 g, 65%). ¹H NMR [CDCl₃, 300 MHz]: δ_{H} 5.53(d, 2H), 7.44, 7.56, 7.95, 8.25, 8.39. ¹³C NMR [CDCl₃, 75 MHz]: δ_{C} 38.9 (t), 123.3 (s), 125.1 (s), 126.8 (s), 127.6 (s), 129.2 (s), 129.9 (s), 133.3 (s).

2-[Anthracene-9-ylmethyl-bis-(2-hydroxy-ethyl)-amino]-ethanol (137)¹³

To a stirred solution of 9-chloromethyl-anthracene **138** (1.0 g, 4.4 mmol) and Na₂CO₃ (0.95 g, 2 eq) in a minimum of hot toluene was added diethanolamine **139** (0.56 g, 5.3 mmol, 1.2 eq). The reaction mixture was refluxed overnight. The solution was filtered hot and allowed to cool to ambient temperature. The solution was extracted with HCl (4M). The acid extract was

neutralized (K_2CO_3) and extracted with chloroform. The organic layer was dried (Na_2SO_4) and the solvent evaporated to yield the crude product as a yellow solid. Recrystallization of this material from EtOAc/ Hexane (50:50) yielded the pure product **137** as a yellow solid (0.8 g, 62%). 1H NMR [$CDCl_3$, 300 MHz]: δ_H 2.82(t, 2H), 3.54 (t, 2H), 4.74 (t, 2H), 7.42-8.46 (m, 9H). ^{13}C NMR [$CDCl_3$, 75 MHz]: δ_C 51.4 (t), 55.8 (t), 59.5 (t), 125.0 (d), 126.0 (d), 127.4 (d), 129.4 (d), 131.2 (s), 131.4 (s).

Attempted synthesis of anthracene ditosylate (142)

To a solution of **137** (0.5 g, 16.9 mmol) and *p*-toluenesulphonyl chloride (0.96 g, 5.1 mmol) in THF (200 ml) was added finely powdered KOH (0.95 g, 16.9 mmol). This mixture was stirred under nitrogen and monitored via TLC (EtOAc). When no reaction was noted the mixture was filtered and the organic layer was dried and concentrated.

Anthracen-9-ylmethyl-bis-(2-chloro-ethyl)-amine (136)

To a solution of **137** (0.65 g, 2.2 mmol) in dichloromethane (40 ml) was added $SOCl_2$ (20 ml). The solution was stirred at reflux temperature overnight. Methanol was added and the solvent removed under reduced pressure. Diethyl ether was added and the solvent removed under reduced pressure. The residue was taken up in EtOAc and extracted with aqueous Na_2CO_3 . The organic layer was dried (Na_2SO_4) and concentrated. The product was purified using column chromatography with EtOAc/ Hexane (5:95) as eluants. The product **136** was obtained as a yellow microcrystalline solid (0.4 g, 55%). 1H NMR [$CDCl_3$, 300 MHz]: δ_H 3.02(t, 2H), 3.42 (t, 2H), 4.65 (t, 2H), 7.42-8.62 (m, 9H). ^{13}C NMR [$CDCl_3$, 75 MHz]: δ_C 42.1 (t), 51.3 (t), 56.2 (t), 125.0 (d), 126.0 (d), 127.4 (d), 129.4 (d), 131.2 (s), 131.4 (s).

Attempted synthesis of the PCU-amino-anthracene macrocycle (134)

To a stirred solution of NaH (0.5 g) in dry THF (250 ml) was added a mixture of **135** (0.2 g, 0.6 mmol) and **136** (0.224 g, 0.5 mmol) in dry THF (100 ml) under a nitrogen atmosphere at room temperature. The solution was stirred at room temperature for 24 h. The reaction was then heated for a further 12 h. The reaction was quenched via the slow addition of water (2 ml). The solvent was removed under reduced pressure and the residue taken up in chloroform. This was extracted with water and the organic layer was dried ($MgSO_4$) and concentrated.

REFERENCES

-
- 1 Cookson, R.C.; Grundwell, E.; Hill, R.R.; Hudec, J. *J. Chem. Soc.* **1964**, 3062.
 - 2 Marchand, A.P.; Chong, H.S.; Alihodzic, S.; Watson, W.H.; Bodige, S.G. *Tetrahedron* **1999**, 55, 9687.
 - 3 Marchand, A.P.; Chong, H.S. *Tetrahedron* **1999**, 55, 9697.
 - 4 Musich, J.A.; Rapoport, H. *J. Am. Chem. Soc.* **1978**, 100, 15, 4865.
 - 5 Matteson, D.S.; Beedle, B.C.; Kandil, A.A. *J. Org. Chem.* **1987**, 52, 5034.
 - 6 Chartres, J.D.; Groth, A.M.; Lindoy, L.F.; Lowe, M.P.; Meehan, G.V. *J. Chem. Soc. Perkin Trans. 1* **2000**, 20, 3444-3450.
 - 7 Cortese, F. in *Organic Syntheses*, Collective Volume 2, **1950**, p 91, John Wiley & Sons Inc.
 - 8 Schutte, E.; Weakley, T.J.R.; Tyler, D.R. *J. Am. Chem. Soc.* **2003**, 125, 10319.
 - 9 Private communication with Dr H.G. Kruger and Dr G.E.M. Maguire, supervisor and co-supervisor.
 - 10 Aizpurua, J.M.; Paloma, C. *Synth. Commun.* **1983**; 13, 745.
 - 11 Huszthy, P.; Oue, M.; Bradshaw, J.S.; Zhu, C.Y.; Wang, T. *J. Org. Chem.* **1992**, 57, 5383.
 12. Aitali, M.; Allaoud, S.; Karim, A.; Meliet, C.; Mortreux, A. *Tetrahedron:Asymmetry* **2000**, 11, 1367.
 - 13 Bissell, R.A.; Calle, E.; de Silva, A.P.; de Silva, S.A.; Gunaratne, H.Q.N.; Habib-Jiwan, J.; Peiris, S.L.A.; Rupasinghe, R.A.D.D.; Samarasinghe, T.K.S.D.; Sandanayake, K.R.A.S.; Soumillion, J. *J. Chem. Soc. Perkin Trans. 2* **1992**, 1559.